

Evaluation of the Buena Vista IBRD Bridge: A Furthering of Accelerated Bridge Construction in Iowa



Final Report
February 2012



IOWA STATE UNIVERSITY
Institute for Transportation

Sponsored by
Iowa Highway Research Board
(IHRB Project TR-605)
Iowa Department of Transportation
(InTrans Project 08-342)

About the BEC

The mission of the Bridge Engineering Center is to conduct research on bridge technologies to help bridge designers/owners design, build, and maintain long-lasting bridges.

Disclaimer Notice

The contents of this report reflect the views of the authors, who are responsible for the facts and the accuracy of the information presented herein. The opinions, findings and conclusions expressed in this publication are those of the authors and not necessarily those of the sponsors.

The sponsors assume no liability for the contents or use of the information contained in this document. This report does not constitute a standard, specification, or regulation.

The sponsors do not endorse products or manufacturers. Trademarks or manufacturers' names appear in this report only because they are considered essential to the objective of the document.

Non-Discrimination Statement

Iowa State University does not discriminate on the basis of race, color, age, religion, national origin, sexual orientation, gender identity, sex, marital status, disability, or status as a U.S. veteran. Inquiries can be directed to the Director of Equal Opportunity and Diversity, (515) 294-7612.

Iowa Department of Transportation Statements

Federal and state laws prohibit employment and/or public accommodation discrimination on the basis of age, color, creed, disability, gender identity, national origin, pregnancy, race, religion, sex, sexual orientation or veteran's status. If you believe you have been discriminated against, please contact the Iowa Civil Rights Commission at 800-457-4416 or Iowa Department of Transportation's affirmative action officer. If you need accommodations because of a disability to access the Iowa Department of Transportation's services, contact the agency's affirmative action officer at 800-262-0003.

The preparation of this (report, document, etc.) was financed in part through funds provided by the Iowa Department of Transportation through its "Agreement for the Management of Research Conducted by Iowa State University for the Iowa Department of Transportation," and its amendments.

The opinions, findings, and conclusions expressed in this publication are those of the authors and not necessarily those of the Iowa Department of Transportation.

Technical Report Documentation Page

1. Report No. IHRB Project TR-605	2. Government Accession No.	3. Recipient's Catalog No.	
4. Title and Subtitle Evaluation of the Buena Vista IBRD Bridge: A Furthering of Accelerated Bridge Construction in Iowa		5. Report Date February 2012	
		6. Performing Organization Code	
7. Author(s) Brent Phares, Terry Wipf, Stuart Nielsen, and Wayne Klaiber		8. Performing Organization Report No. InTrans Project 08-342	
9. Performing Organization Name and Address Bridge Engineering Center Iowa State University 2711 South Loop Drive, Suite 4700 Ames, IA 50010-8664		10. Work Unit No. (TRAIIS)	
		11. Contract or Grant No.	
12. Sponsoring Organization Name and Address Iowa Highway Research Board Iowa Department of Transportation 800 Lincoln Way Ames, IA 50010		13. Type of Report and Period Covered Final Report	
		14. Sponsoring Agency Code	
15. Supplementary Notes Visit www.intrans.iastate.edu for color PDFs of this and other research reports.			
16. Abstract <p>The need to construct bridges that last longer, are less expensive, and take less time to build has increased. The importance of accelerated bridge construction (ABC) technologies has been realized by the Federal Highway Administration (FHWA) and the Iowa Department of Transportation (DOT) Office of Bridges and Structures. This project is another in a series of ABC bridge projects undertaken by the Iowa DOT.</p> <p>Buena Vista County, Iowa, with the assistance of the Iowa Department of Transportation (DOT) and the Bridge Engineering Center (BEC) at Iowa State University, constructed a two-lane single-span precast box girder bridge, using rapid construction techniques. The design involved the use of precast, pretensioned components for the bridge superstructure, substructure, and backwalls.</p> <p>This application and demonstration represents an important step in the development and advancement of these techniques in Iowa as well as nationwide. Prior funding for the design and construction of this bridge (including materials) was obtained through the FHWA Innovative Bridge Research and Deployment (IBRD) Program. The Iowa Highway Research Board (IHRB) provided additional funding to test and evaluate the bridge.</p> <p>This project directly addresses the IBRD goal of demonstrating (and documenting) the effectiveness of innovative materials and construction techniques for the construction of new bridge structures. Evaluation of performance was formulated through comparisons with design assumptions and recognized codes and standards including American Association of State Highway and Transportation Officials (AASHTO) specifications.</p>			
17. Key Words accelerated bridge construction—box girder bridges—bridge design—bridge structures—innovative bridge construction—precast bridge components—rapid bridge construction— single-span precast—structural performance		18. Distribution Statement No restrictions.	
19. Security Classification (of this report) Unclassified.	20. Security Classification (of this page) Unclassified.	21. No. of Pages 92	22. Price NA

EVALUATION OF THE BUENA VISTA IBRD BRIDGE: A FURTHERING OF ACCELERATED BRIDGE CONSTRUCTION IN IOWA

**Final Report
February 2012**

Co-Principal Investigators

Brent Phares, Associate Director
Bridge Engineering Center
Iowa State University

Terry Wipf, Professor
Civil, Construction, and Environmental Engineering
Iowa State University

Jon Ites, Buena Vista County Engineer

Wayne Klaiber, Professor Emeritus
Civil, Construction, and Environmental Engineering
Iowa State University

Authors

Brent Phares, Terry Wipf, Stuart Nielsen, and Wayne Klaiber

Sponsored by
the Iowa Highway Research Board
(IHRB Project TR-605)

Preparation of this report was financed in part
through funds provided by the Iowa Department of Transportation
through its research management agreement with the
Institute for Transportation
(InTrans Project 08-342)

A report from
Bridge Engineering Center
Iowa State University
2711 South Loop Drive, Suite 4700
Ames, IA 50010-8664
Phone: 515-294-8103
Fax: 515-294-0467
www.intrans.iastate.edu

TABLE OF CONTENTS

ACKNOWLEDGMENTS	ix
EXECUTIVE SUMMARY	xi
1. GENERAL INFORMATION.....	1
1.1 Introduction.....	1
1.2 Background.....	2
1.3 Objectives and Scope.....	2
1.4 Bridge Concept	3
2. BRIDGE DESCRIPTION.....	6
2.1 Fabrication	15
2.2 Preconstruction-Plant Assembly.....	18
2.3 Field Construction Observation	20
3. FIELD TESTING.....	31
3.1. Instrumentation	31
3.2. Testing.....	31
4. FIELD TEST RESULTS	39
4.1. Loading Cases.....	39
5. SUMMARY, CONCLUSIONS, AND RECOMMENDATIONS	63
REFERENCES	65
APPENDIX A. BUENA VISTA BOX GIRDER BRIDGE PLANS	67

LIST OF FIGURES

Figure 1.1. Concept model showing final bridge.....	3
Figure 1.2. Schematic of precast abutment cap	4
Figure 1.3. Precast backwall and abutment	4
Figure 1.4. Voided slab precast deck beams.....	5
Figure 1.5. Guardrail posts.....	5
Figure 2.1. Location of Buena Vista County precast bridge.....	6
Figure 2.2. Original bridge at demonstration site	6
Figure 2.3. New Buena Vista County box beam bridge	7
Figure 2.4. Plan and section of bridge	8
Figure 2.5. Abutment backwall details	9
Figure 2.6. Abutment cap details	10
Figure 2.7. Box beam dimensions.....	12
Figure 2.8. Box beam details	13
Figure 2.9. Box beam guardrail system	14
Figure 2.10. Box beam fabrication	16
Figure 2.11. Backwall formwork.....	17
Figure 2.12. Abutment cap forms	18
Figure 2.13. Prefabricated abutments in precast yard.....	19
Figure 2.14. Voided precast beams.....	19
Figure 2.15. Precast backwall and abutment	20
Figure 2.16. Abutment construction	21
Figure 2.17. Order of box beam placement	22
Figure 2.18. Construction of the superstructure.....	23
Figure 2.19. Installation of precast backwalls and guardrail system	27
Figure 2.20. Time-lapse camera at bridge site during bridge construction	30
Figure 3.1. Instrumentation layout.....	32
Figure 3.2. Relative displacement transducer between DBs 5 and 6.....	34
Figure 3.3. Transverse load positions: vehicle traveled east (into page).....	35
Figure 3.4. Dimensions and weights of test trucks used in 2009 and 2010 bridge field tests	37
Figure 3.5. Trucks on bridge during 2010 LC7 test.....	38
Figure 4.1. Representative time history – 2009 deflections.....	40
Figure 4.2. 2009 Transverse deflected shape at midspan and quarterspan	44
Figure 4.3. Representative time history differentials.....	45
Figure 4.4. Representative time history – 2010 differentials.....	48
Figure 4.5. 2009 and 2010 Differential deflections	50
Figure 4.6. Midspan strains for various load cases.....	53
Figure 4.7. 2009 Experimental strains for LC1	55
Figure 4.8. 2010 Experimental strains for LC1	56
Figure 4.9. Experimentally-determined load fractions	57
Figure 4.10. Experimental and codified load distributions for one truck on bridge.....	59
Figure 4.11. Experimental and codified load distribution for lane loading	61

LIST OF TABLES

Table 2.1. Precast concrete strengths	15
Table 2.2. Precast element cast dates.....	18
Table 2.3. Box beam erection times.....	22
Table 2.4. Key to images in Figure 2.18 and the various phases of bridge construction	26
Table 2.5. Key to images in Figure 2.19 and the various phases of backwall and guardrail construction.....	29
Table 4.1. 2009 Maximum midspan girder deflection.....	39
Table 4.2. 2009 Maximum differential movement	49
Table 4.3. 2010 Maximum differential movement	49
Table 4.4. 2009 Maximum midspan girder strains	52
Table 4.5. 2010 Maximum midspan girder strains	52

ACKNOWLEDGMENTS

The authors wish to thank the Iowa Highway Research Board, the Iowa Department of Transportation, Buena Vista County, and the Federal Highway Administration for providing funding, design expertise, and research collaboration for this project.

Special recognition is given to the following individuals for their significant contributions to the research: Ahmad Abu-Hawash and several other staff from the Office of Bridges and Structures at the Iowa Department of Transportation; Chris Cromwell and his predecessor Curtis Monk, Federal Highway Administration Iowa Division, Jon Ites and other Buena Vista County staff members; Doug Wood, manager of the Civil, Construction, and Environmental Engineering Department Structural Engineering Laboratory at Iowa State University; Travis Hosteng, bridge research engineer; and numerous departmental graduate and undergraduate students.

Special thanks are accorded Adam Rohlfesen of Andrews Prestressed Concrete, Inc. for providing data and images of the various precast elements during fabrication.

EXECUTIVE SUMMARY

The importance of accelerated bridge construction (ABC) technologies has been realized by the Federal Highway Administration (FHWA) and the Iowa Department of Transportation (DOT) Office of Bridges and Structures. This project, which involved the construction of a two-lane single-span precast box girder bridge, is another in a series of ABC bridge projects undertaken by the Iowa DOT.

Buena Vista County, Iowa, with the assistance of the Iowa DOT and the Bridge Engineering Center (BEC) at Iowa State University, constructed this bridge using rapid construction techniques. The design involved the use of precast, pretensioned components for the bridge superstructure, substructure, and backwalls.

The successful implementation of this approach may have far-reaching implications in Iowa where proven rapid construction techniques could result in significant cost reductions. This application and demonstration represents an important step in the development and advancement of these techniques in Iowa as well as nationwide.

Prior funding for the design and construction of this bridge (including materials) was obtained through the FHWA Innovative Bridge Research and Deployment (IBRD) Program. The Iowa Highway Research Board (IHRB) provided additional funding to test and evaluate the bridge.

This project directly addresses the IBRD goal of demonstrating (and documenting) the effectiveness of innovative materials and construction techniques for the construction of new bridge structures. The objectives of this project included the following:

- Assist the Iowa DOT and Iowa county engineers in demonstrating the benefits of precast, post-tensioned bridge components through this project and provide an opportunity for them to design and construct more cost-effective, durable bridges
- Perform testing and evaluation of precast components for the bridge project to assess overall design, construction, and structural performance

It took only five calendar days to remove the existing bridge and replace it with the new precast bridge; the approaches that were completed by county crews took an additional 14 days. Precast elements in the bridge included precast cap beams, precast backwalls, and precast/prestressed box girders. Construction of the bridge, as well as fabrication of the various precast elements, were closely observed.

Upon completion of the bridge in 2009, it was instrumented and load tested using two county trucks loaded with gravel. Approximately one year later, instrumentation was re-installed and the bridge was tested a second time to determine any changes in its performance and/or behavior in that time.

As expected, the bridge performed well and there was essentially no change in its behavior in the time period between the two tests.

1. GENERAL INFORMATION

1.1 Introduction

Interest in constructing bridges that last longer, are less expensive, and take less time to construct has increased. This is known as the “get in, get out, and stay out” philosophy. The idea is to increase the cost-effectiveness of bridges by increasing their durability (i.e., useful life) and by minimizing disruptions to the traveling public. Clearly, there is much to learn about how to best accomplish this nationally-important goal.

Although there may be many ways to achieve this goal, the ideas discussed most commonly at this time include using some form of precast, segmental construction. This type of construction has the advantage that the individual components are manufactured off-site where improved quality is usually achieved. Furthermore, because much of the work is completed away from the bridge site, it is anticipated that user disruptions are minimized given the amount of labor-intensive on-site work that is reduced, leading to reduced on-site construction time.

Buena Vista County, Iowa, with the assistance of the Iowa Department of Transportation (DOT) and the Bridge Engineering Center (BEC) at Iowa State University, constructed a single-span bridge using rapid construction techniques. The design concept used in this bridge involved the use of precast, posttensioned components for the bridge substructure, superstructure, and backwalls. This application and demonstration represents another important step in the development and advancement of these techniques in Iowa as well as nationwide.

Prior funding for the design and construction (which included materials) of this project was obtained through the Innovative Bridge Research and Deployment (IBRD) Program sponsored by the Federal Highway Administration (FHWA). One requirement of the IBRD Program is that the resulting bridge be tested and evaluated. To meet the obligations of the previously-obtained IBRD funding, supplemental funding was obtained from the Iowa Highway Research Board (IHRB).

The successful implementation of this approach has far reaching implications in Iowa, as there are many instances where proven rapid construction techniques could result in significant reductions in costs and construction time. This project directly addresses the IBRD goal of demonstrating (and documenting) the effectiveness of innovative materials and construction techniques for new bridge structures.

This report documents the Buena Vista County (BVC) precast bridge including its fabrication, construction, and field testing. The BVC precast bridge is a longitudinally-pretensioned, two-lane, single-span box girder bridge that spans 50 ft center to center of supports.

1.2 Background

The box girder design used for the BVC Bridge is based on designs, used by the Illinois DOT (IDOT), which are either 36 in. or 48 in. wide and which vary in depth. Shallower beams contain circular voids and welded wire fabric for the shear reinforcement. Deeper beams contain rectangular voids and the shear reinforcement consists of deformed bars. The deeper beams are usually limited to the 36 in. width to restrict the weight and size of the girders. This allows for easy transportation to the project site and placement with a mobile crane (Hawkins and Fuentes 2002).

Precast prestressed concrete box girder bridges were widely used for Illinois state highways during the 1960s and 1970s; however, use of these bridges has been discontinued for their state highways due to corrosion problems. About 10 percent of prestressed box girder bridges inventoried on Illinois state highways had experienced significant corrosion, leading to a decreased bridge rating and the installment of load restrictions. However, because these bridges are economical to build, they are still widely used on county roads throughout Illinois (Hawkins and Fuentes 2002).

According to published literature, differential deflections between adjacent girders allowed the development of reflective cracks along the longitudinal joint between girders. Corrosion of the prestressing strands resulted from salt-laden water seeping through the cracked joint and into the girder. County engineers believe a lack of transverse load distribution between adjacent girders is the cause for the longitudinal cracking (Hawkins and Fuentes 2003).

Two solutions used by IDOT to resolve this problem include post-tensioning the girders together transversely and providing a composite cast-in-place concrete deck. Both solutions have worked satisfactorily, but add to the cost of construction considerably, do not ensure that corrosion will be prevented, and make replacing damaged girders more difficult. These modifications are also not reasonable solutions for retrofitting bridges currently in service (Hawkins and Fuentes 2003).

The BVC box beam bridge is the second box beam bridge constructed in Iowa. The first one, constructed in Madison County in 2007 (Phares et al. 2009), is 46 ft 8 in. center to center of supports. It is 24 ft 1 in. wide and consists of six box beams (4 ft wide and 2 ft 3 in. deep), each of which has a rectangular void.

1.3 Objectives and Scope

The overall objective of this project was to evaluate the BVC precast bridge components and assess the overall design, construction, and structural performance. To accomplish the objectives, the project included the following tasks:

- Design the bridge substructure elements (piling, precast abutment caps, and precast backwalls) and superstructure elements (box beams). This task was completed by the Iowa DOT Office of Bridges and Structures.

- Document fabrication of the various bridge elements and actual construction of the bridge.
- Develop a monitoring plan to evaluate the structural performance of the bridges as well as the individual box beam elements.
- Evaluate the structural performance of the bridge by using the monitoring plan developed in the earlier task and subjecting the bridge to live load tests. One test was completed when the construction was completed and a second test was undertaken about a year later.
- The final task of the project is the preparation and submission of a final report that presents the results of the various project tasks.

1.4 Bridge Concept

The BVC box beam bridge was another step in developing an accelerated bridge construction program in Iowa. This box beam bridge was designed by Stuart Nielsen of the Iowa DOT Office of Bridges and Structures for HL-93 loading using the 2007 Load and Resistance Factor Design (LRFD) specifications.

The BVC Bridge is a nominal 50 ft long and 28 ft wide. (A complete set of plans for this bridge is included in Appendix A.) Several three-dimensional (3D) images were also created by Nielsen to assist the contractor in visualizing the accelerated bridge construction process. An overall view of the concept model of the bridge is shown in Figure 1.1.



Figure 1.1. Concept model showing final bridge

Abutments were a combination of piling driven in the field (5 for each abutment) and precast abutment caps (3 ft x 3 ft x 28 ft), which were cast with five voids (21 in. in diameter to accommodate the piling (Figure 1.2a). The combination of the piling and precast abutment cap is shown in Figure 1.2b.

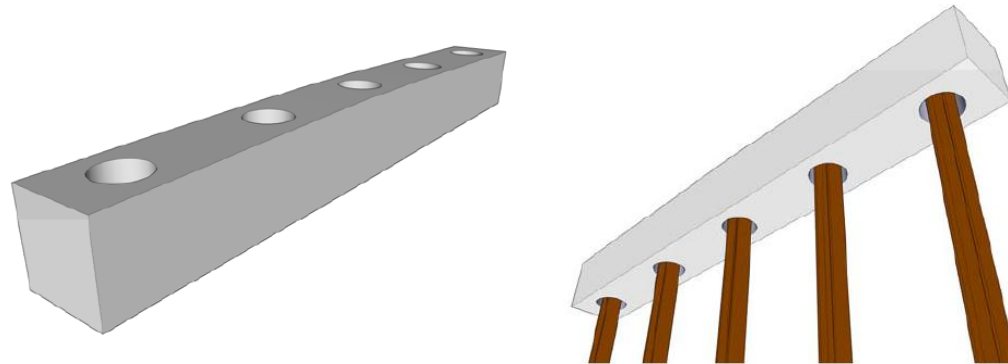

a.) Precast abutment

b.) Precast abutment on piles

Figure 1.2. Schematic of precast abutment cap

Precast abutment caps were used on two previous accelerated bridge construction projects—one in Madison County (Phares et al. 2009) and one in Boone County (Klaiber et al. 2009). As a result of these successful applications, they were used on this bridge. This is, however, the first accelerated bridge project in which precast backwalls were used (Figure 1.3).

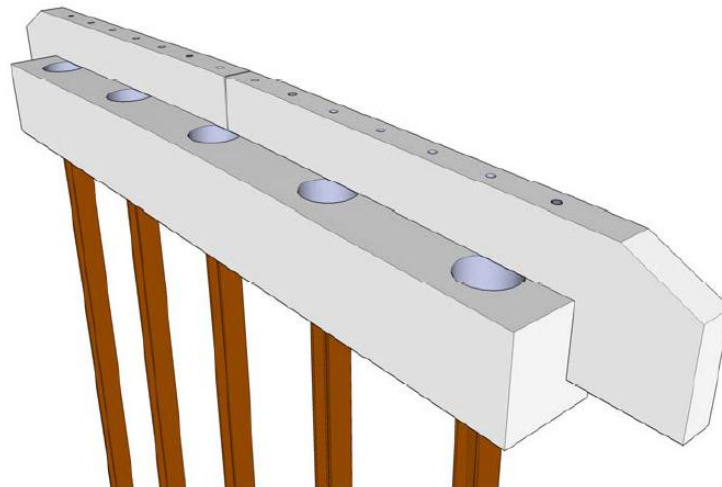

Figure 1.3. Precast backwall and abutment

As shown in Figure 1.3, the precast backwall units were attached to the abutment caps with dowels. The backwalls were actually placed after the seven precast box beams (Figure 1.4) were set.

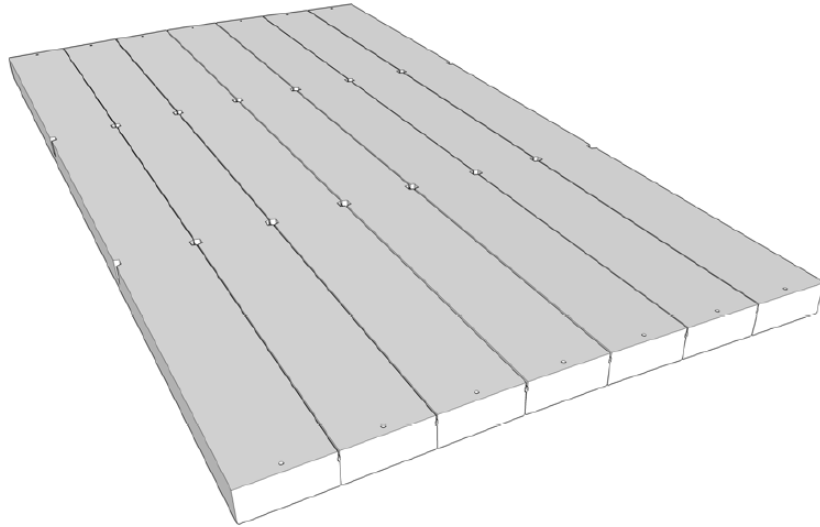

Figure 1.4. Voided slab precast deck beams

The box beam units (4 ft x 1 ft 9 in x 50 ft 10 in) were connected to the precast abutments with 1.5 in diameter dowels; they were connected transversely at the third points with 1 in. diameter thread rods.

A schematic of the various precast elements assembled and the guardrail posts and piling are shown in Figure 1.5.

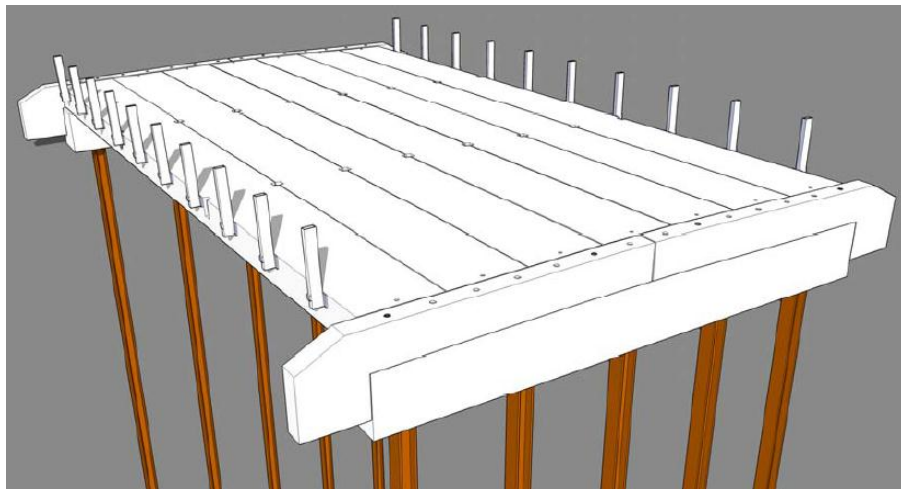

Figure 1.5. Guardrail posts

The guardrail posts were attached to the exterior box beams using anchor bolts that had been cast in these units. In this report, the terms box beam, deck beam, and simple beam have been used to describe the flexural elements.

2. BRIDGE DESCRIPTION

The box beam bridge is located on a low-volume road (640th Street) in Buena Vista County close to Storm Lake as shown in Figure 2.1.

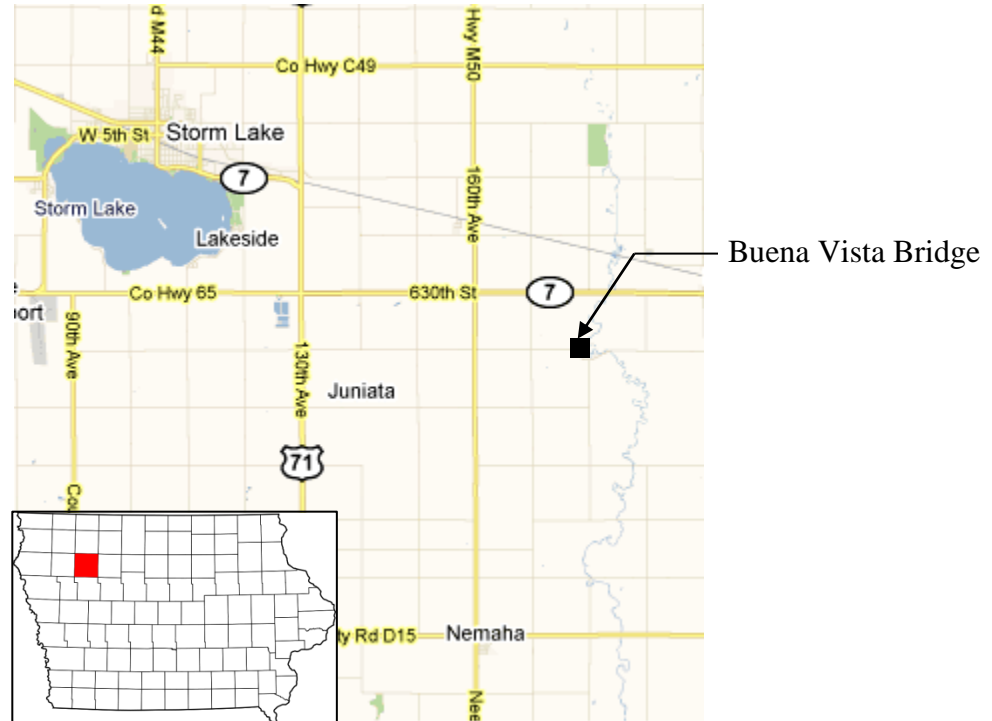

Figure 2.1. Location of Buena Vista County precast bridge

The new bridge replaced a posted timber bridge (26 ft 8 in. long by ~ 18 ft wide) that was constructed in 1936. The original bridge is shown in Figure 2.2.



a. Elevation



b. End view

Figure 2.2. Original bridge at demonstration site

The new bridge, shown in Figure 2.3, has precast abutment caps, backwalls, and box beams; and, this single-span bridge has a span length of 50 ft center to center of supports.



a. Elevation



b. End view

Figure 2.3. New Buena Vista County box beam bridge

Overall dimensions of the bridge (shown in Figure 2.4) are out-to-out deck width of 28 ft and out-to-out length of 50 ft 10 in.

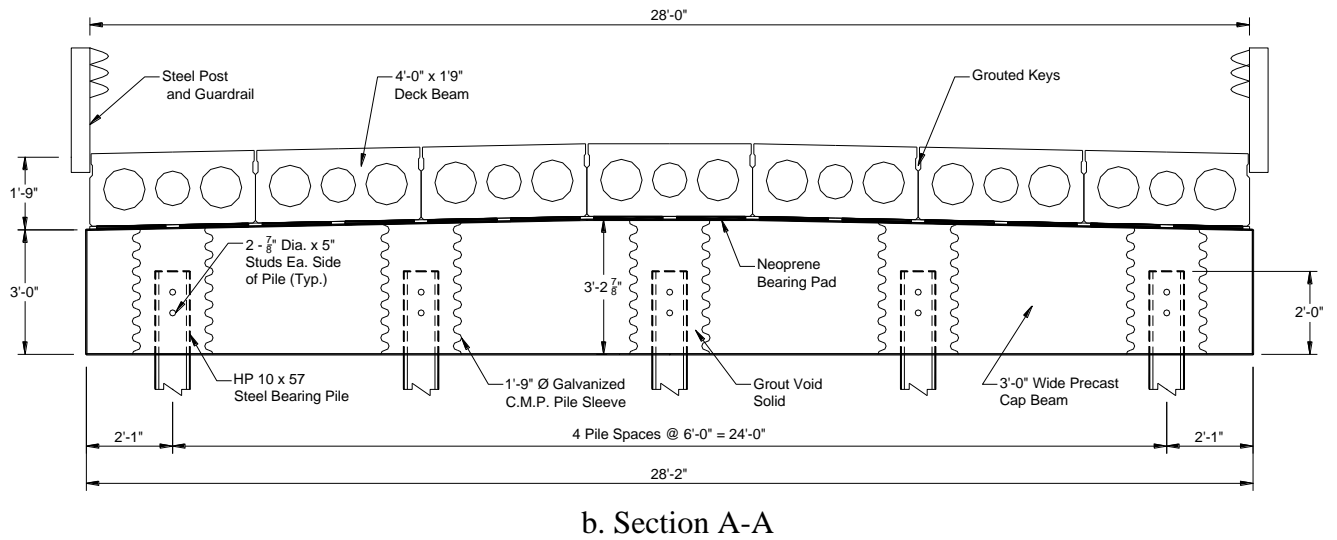
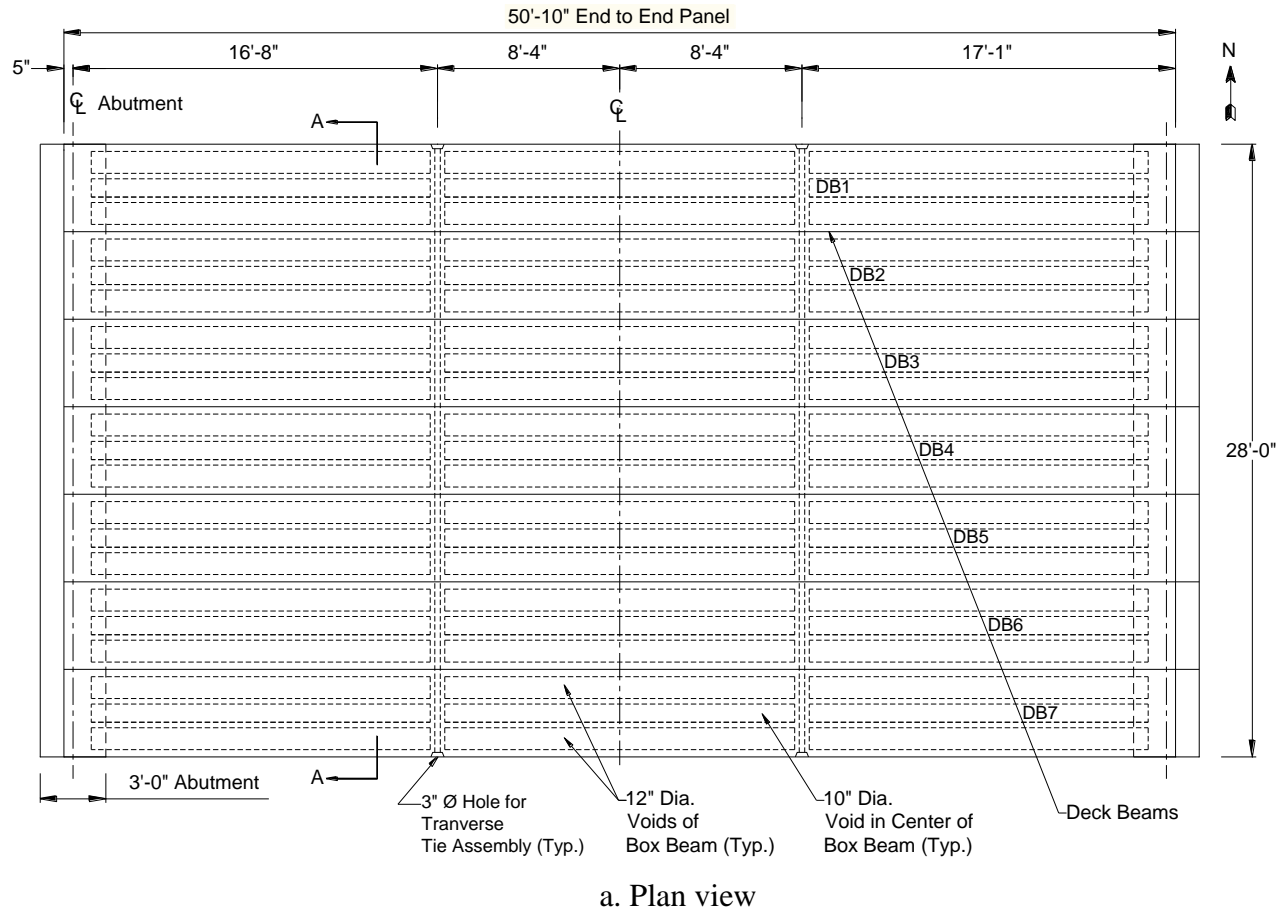
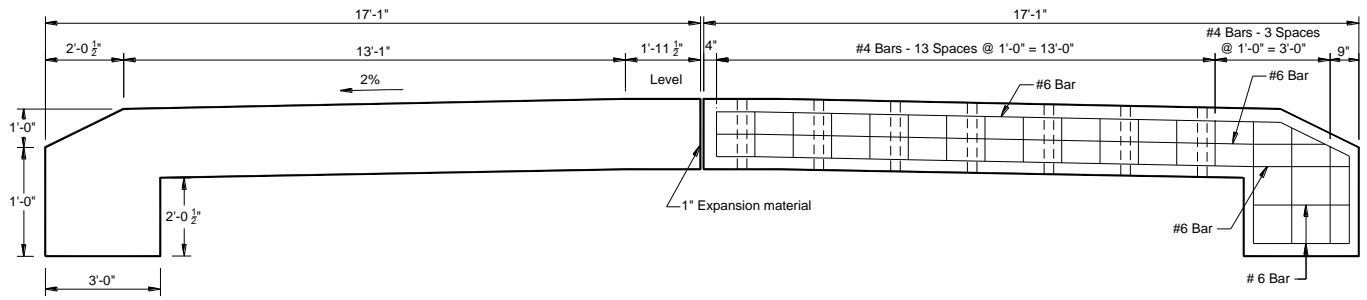
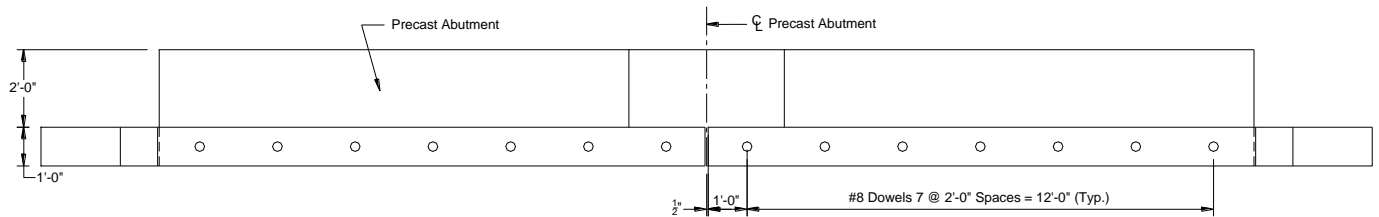

Figure 2.4. Plan and section of bridge

As previously mentioned, this bridge had several precast elements: two abutment caps, four backwall segments, and seven precast, prestressed box beams. Details of the abutment backwalls are shown in Figure 2.5. Each backwall was comprised of two precast segments.



a. Elevation view



b. Plan view



c. Wing wall segments

Figure 2.5. Abutment backwall details

Abutment caps details are shown in Figure 2.6. As shown in Figure 2.6a, the precast abutment cap is 26 ft 2 in long, 3 ft wide, and varies in depth from 3 ft at the ends to 3 ft 2 7/8 in. deep at the centerline. Voids in the caps, created by 21 in. diameter corrugated metal pipe (CMP), are to accommodate the piling.

Abutment cap reinforcement details are shown in Figures 2.6b and 2.6c and one of the caps is shown in Figure 2.6d. As Figure 2.6b shows, the primarily longitudinal reinforcement is eight #8 bars, and #5 bars are used for the shear reinforcement.

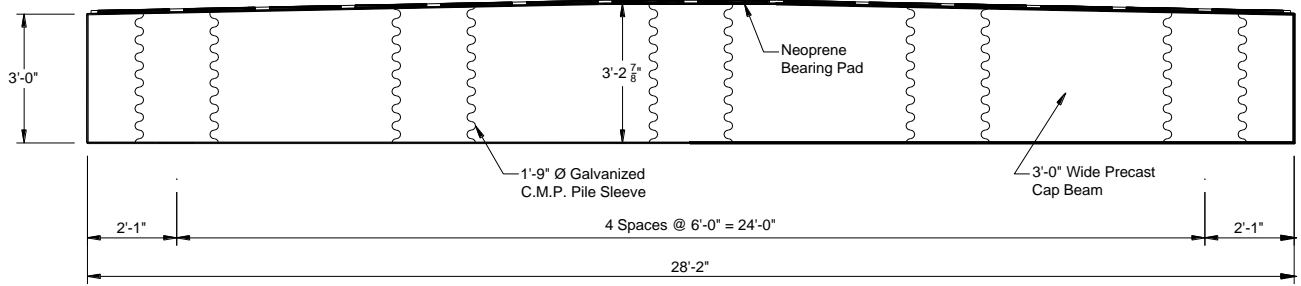

a. Overall dimensions

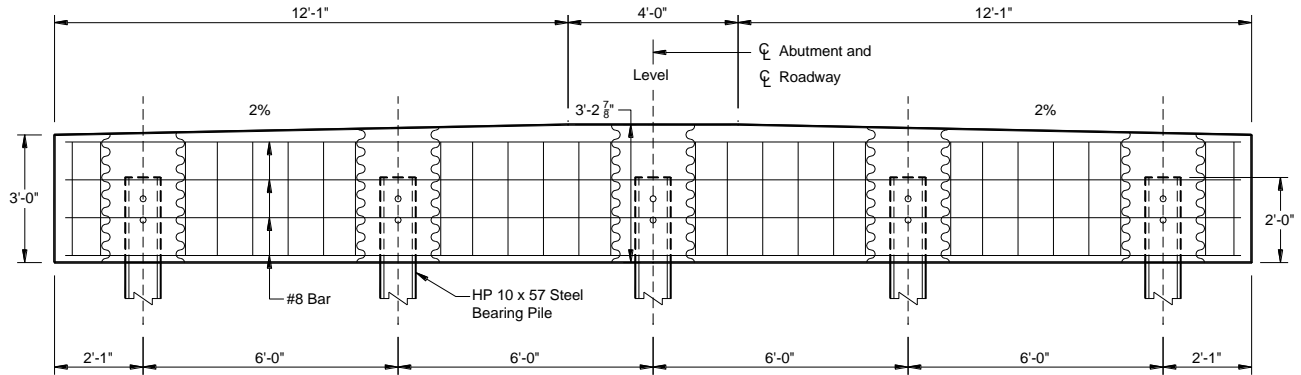

b. Reinforcement details – side view

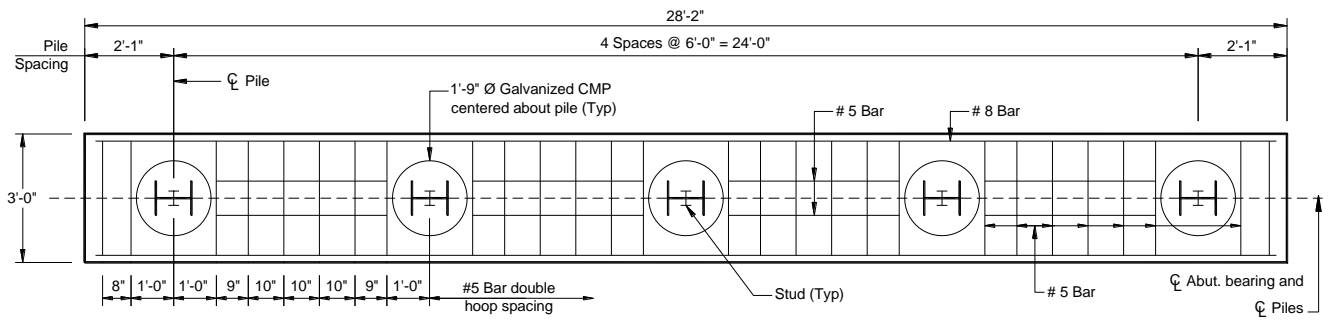

c. Reinforcement details – top view



d. Abutment cap

Figure 2.6. Abutment cap details

Details on the seven box beams in the bridge are shown in Figures 2.7 and 2.8. Overall dimensions of the box beams, as shown in Figure 2.7, are 50 ft 10 in. long, 4 ft wide, and 21 in. deep. Each unit has three circular voids—two 12 in. in diameter and one 10 in. in diameter.

As shown in Figure 2.7a, the box beams were solid concrete 1 ft 3 in. from each end and for 8 in. around the two transverse tie regions. The 12 in. and 10 in. diameter voids created top and bottom slab thicknesses varying between 4 1/2 and 5 1/2 in., and a total nominal web thickness of 14 in., which is divided among the four webs that vary in thickness due to the circular voids.

Shear keys (4 in. x 3/4 in.) in the vertical faces of the box girders are shown in Figure 2.7c. As the purpose of the shear keys is to transfer a portion of the load between adjustment units, only interior beam units have shear keys in both vertical faces. The two exterior beams only have shear keys on their interior faces. However, exterior units do have inserts in the exterior face for attachment of the guardrails.

Reinforcement details for the box girders are shown in Figure 2.8. One-half inch diameter, seven-wire, uncoated, low-relaxation, prestressing strand plus mild #4 (Grade 60) reinforcing bars were used for the flexural reinforcement. Twenty-eight strands were in the bottom of the slab and two strands were in the top of the slab; and, a total initial prestress of 900.5 kips was applied to the straight strands.

Shear reinforcement consisted of overlapping #4 U-shaped bars. These stirrups were on 6 in. centers in the region 3 ft from the beam ends, then on 9 in. centers for the next 6 ft, and then on 12 in. centers in the remaining portion of the beams, except in the vicinity of the transverse tie where the spacing was reduced to 6 in. (see Figures 2.8a and 2.8b).

The two exterior box beams were fabricated with 1 in. diameter anchor bolts on their exterior sides for connecting the eight guardrail posts. The posts were spaced uniformly on 6 ft 3 in. centers as shown in Figure 2.9.

Two anchor bolts (spaced 2 3/4 in. off the post centerline) were required for attaching each post. Guardrail posts (3 ft 4 in. long) were fabricated from TS 6 x 3 x 1/4 in. sections; a 12 gauge thrie beam was used for the guardrail. Each post is connected to a 3/4 in. thick steel base plate (8 in. x 7 in.) with a 3/4 in. diameter A325 bolt and a 3/8 in. diameter bolt. This assembly was connected to the bridge using the two 1 in. diameter anchor bolts described previously.

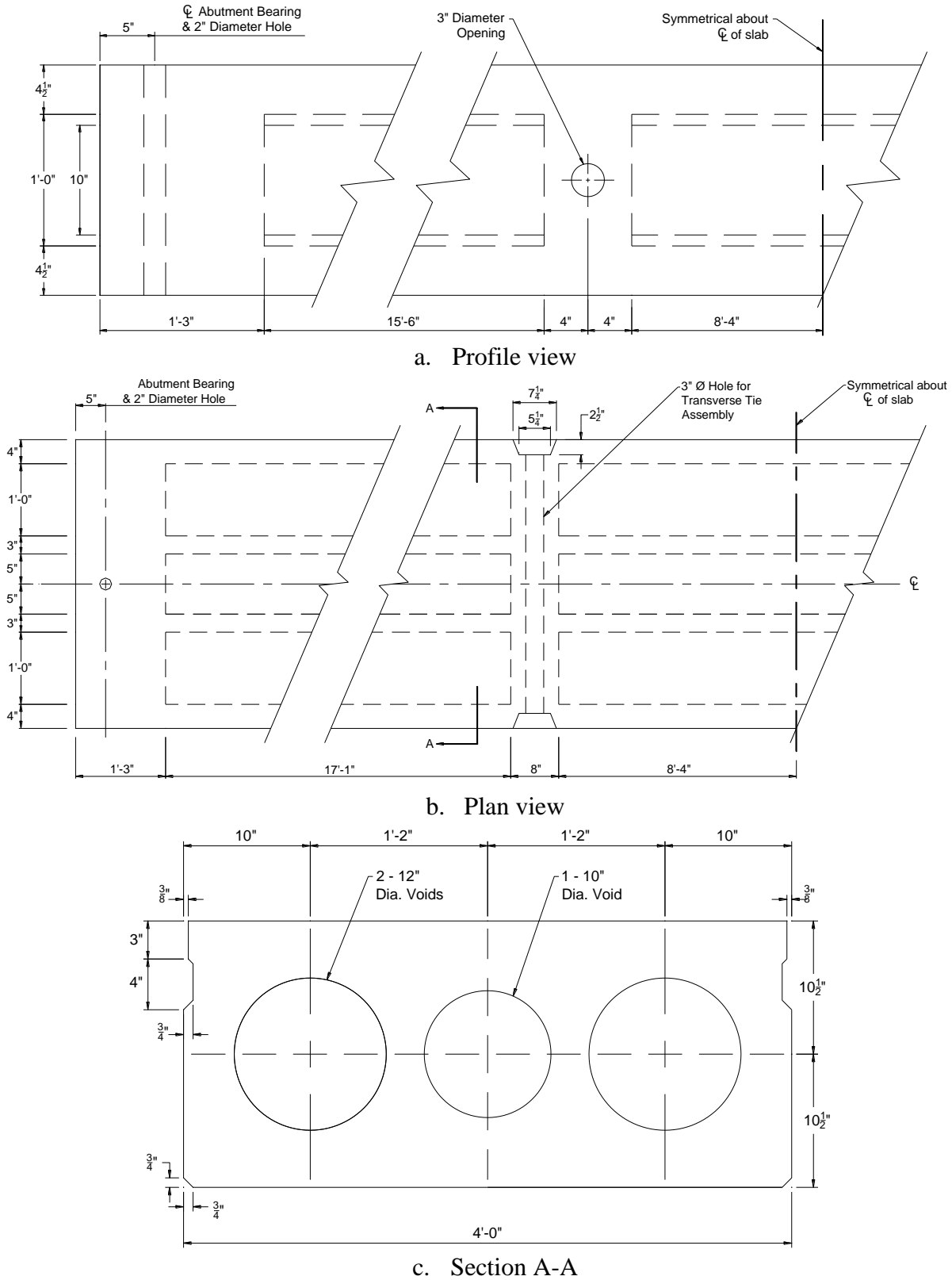
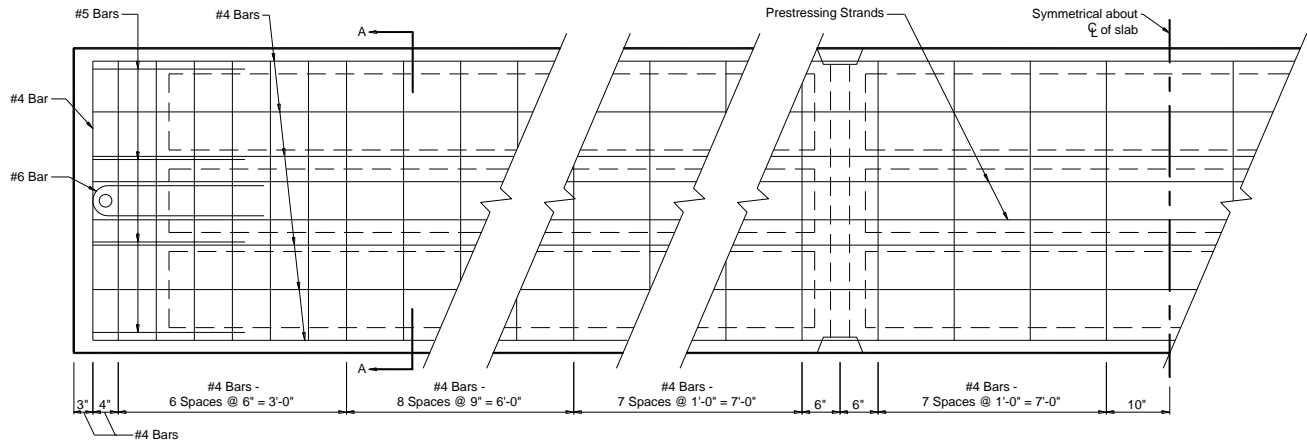
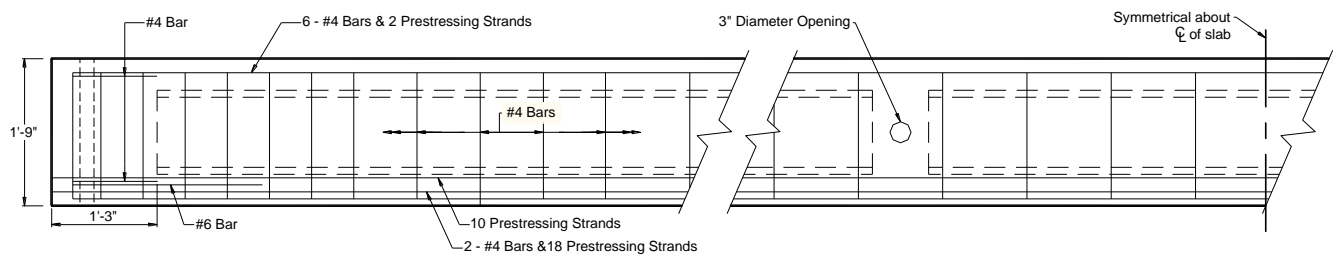

Figure 2.7. Box beam dimensions



a. Top slab reinforcement



b. Profile view of reinforcing layout

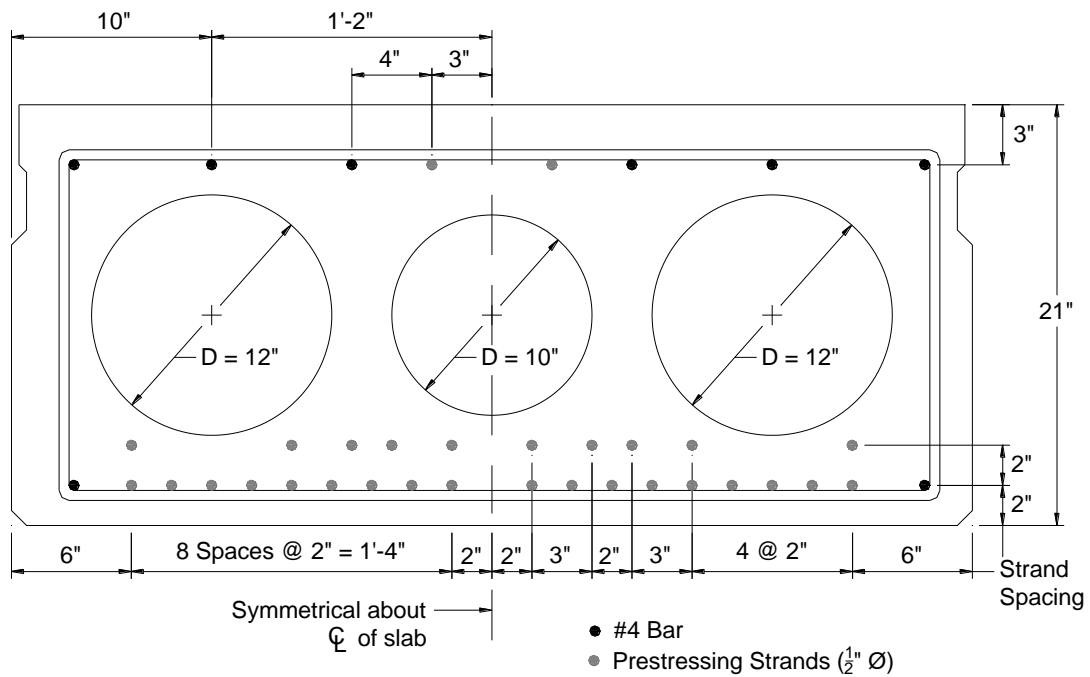

c. Section A-A

Figure 2.8. Box beam details

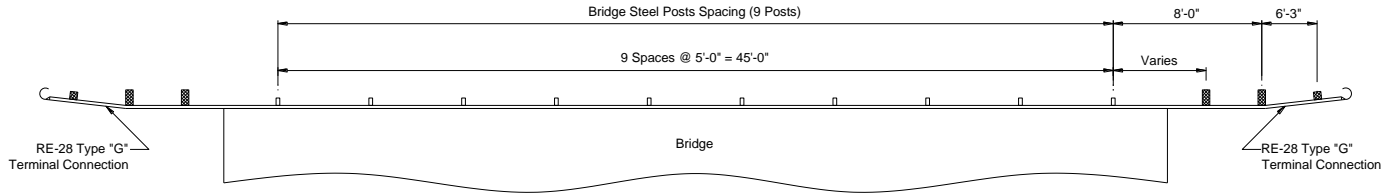

a. Plan view of guardrail post spacing

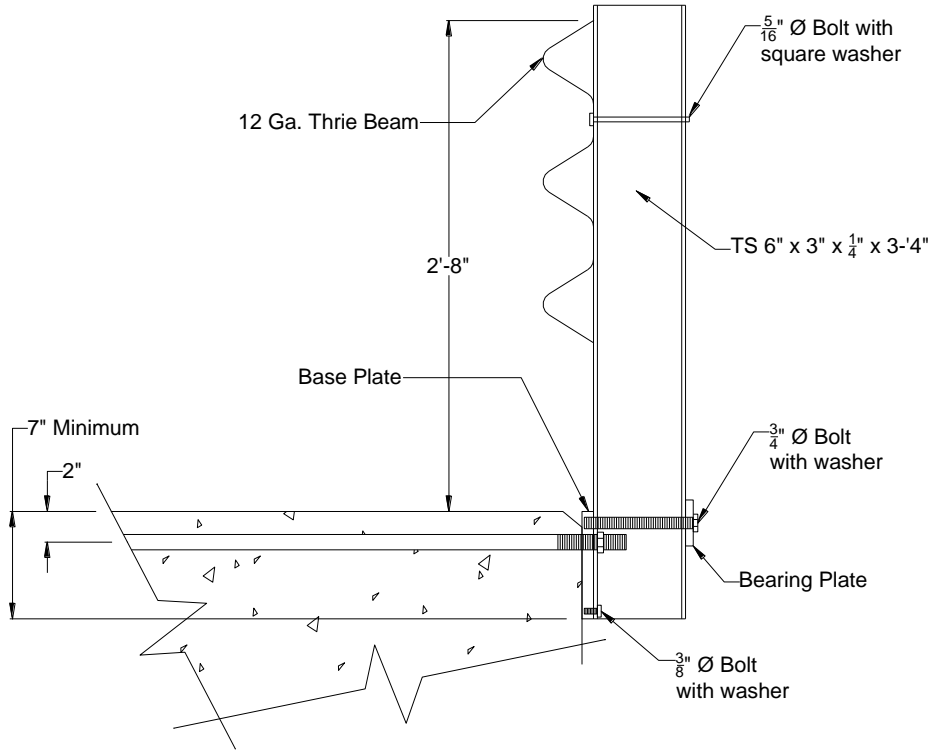

b. Profile view of guardrail and connection

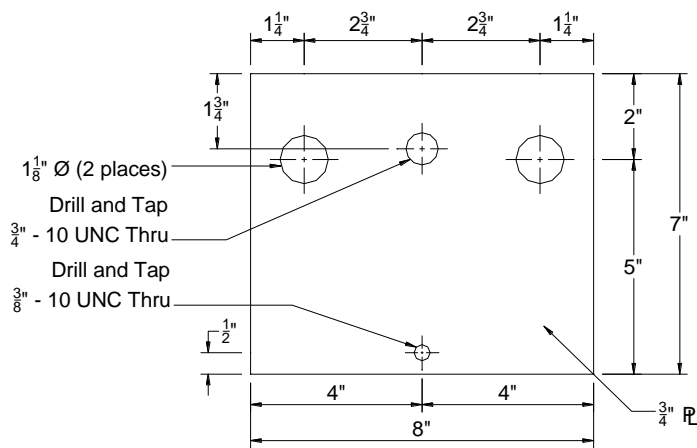

c. Base plate

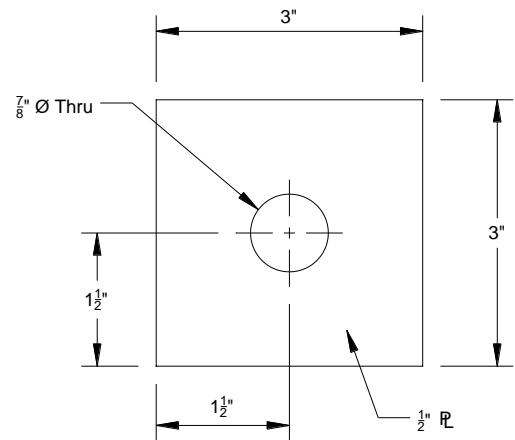

d. Bearing plate

Figure 2.9. Box beam guardrail system



e. Guardrail system

Figure 2.9. Continued

2.1 Fabrication

Initial casting began July 21, 2009 and was completed August 25, 2009. Two abutment caps, four wing wall sections, and seven box girders were cast. The target concrete strengths, as well as the actual strengths obtained, are shown in Table 2.1.

Table 2.1. Precast concrete strengths

Element	Concrete Strength (psi)	
	Target	Obtained
Abutment 1	5,000	5,800
Abutment 2	5,000	6,200
Backwalls	5,000	6,290 (avg)
Box Beams (at release)	6,000	6,225 (avg)
Box Beams (28 day)	7,000	7,710 (avg)

As may be observed, concrete strengths in all elements exceeded the design target values. For convenience, box girders were cast two at a time in one prestressing bed with bulkheads separating the two girders. Because seven box girders were required for the project, only one girder was cast in one of the pours. Figure 2.10 shows the top reinforcement in the box beams.



a. Overall view



b. Placement of concrete in box beam forms

Figure 2.10. Box beam fabrication

As illustrated, the corner #4 bars, as well as the corner #4 bars in the bottom layer, were replaced with 1/2 in. diameter prestressing strand tensioned to 3,000 lbs. The reason for replacing the four #4 bars (shown in Figure 2.8c) was to create more rigidity at the corners to simplify tying the shear reinforcement. Thus, reinforcement in the top layer was four prestressing strands (two fully-stressed and two stressed to 3,000 lbs) and four #4 bars.

Also shown in this figure are the Styrofoam cylinders used to create the voids in the box girders. Hold-downs to keep the Styrofoam from floating are shown in Figure 2.10a. As shown in Figure 2.10b, the Styrofoam cylinders were terminated 1 ft 3 in. from the beam ends to create the solid beam ends. Two other items, which can be seen in Figure 2.10b, are the guardrail post anchor rods and the cable-lifting loops, which are cut off after the box beams are placed in the field.

Backwall elements were cast one at a time; formwork, as well as the reinforcement for these elements, are shown in Figure 2.11. For installation, each of the backwall panels had three cable lifting loops and two screw inserts for additional lifting points.



Figure 2.11. Backwall formwork

The two abutment caps were also cast one at a time. Figure 2.12 shows the abutment cap formwork, one of the two required cable lifting loops, reinforcement, and two of the five pieces of CMP, required to create voids for the piling.



Figure 2.12. Abutment cap forms

The dates the various elements were cast are shown in Table 2.2, as well as the release times for the seven box beams.

Table 2.2. Precast element cast dates

Element	Cast Date (2009)	Release Time
Box Beams 2 and 3	August 11	15 hours
Box Beams 4 and 5	August 14	2.5 days*
Box Beam 6	August 18	15.8 hours
Box Beams 1 and 7	August 25	15.5 hours
Backwall 1	July 27	N/A
Backwall 2	July 28	N/A
Backwall 3	July 29	N/A
Backwall 4	July 30	N/A
Abutment Cap 1	July 21	N/A
Abutment Cap 2	July 23	N/A

*Poured on Friday and released on Monday

N/A = Not applicable as elements not prestressed

Concrete strengths in the box beams at release were presented in Table 2.1. Given the elements were cast in the summer, no additional heat was required for curing.

2.2 Preconstruction-Plant Assembly

Prior to being shipped to the bridge site, the individual precast elements were inspected and partially assembled in the precast yard to ensure the elements fit together properly. This step also gave the contractor, who was new to this type of construction, a chance to review the various elements and ask questions about the construction sequence. Images of the precast abutments in the precast yard are shown in Figure 2.13.



a. Overall view of precast abutment



b.) Precast abutment pile connection openings

Figure 2.13. Prefabricated abutments in precast yard

The fit between two adjacent box beams is shown in Figure 2.14. In this setup, the trueness of the elements, as well as the alignment of the transverse tie assembly, could be checked.



Figure 2.14. Voided precast beams

Figure 2.15 shows one of the backwall segments positioned on the precast abutment cap. The four backwall segments were cast “flat” and lifted out of the forms using the three lift cables shown in this figure.

To lift the backwall segments into place, lifting hooks were attached with bolts screwed into inserts in the top of the backwall elements (Figure 2.15). After the 13 elements were inspected and partial assembly was completed, these were stored at the precast yard until needed at the bridge site.

Construction of the bridge in the field is presented in the next section of this chapter.



Figure 2.15. Precast backwall and abutment

2.3 Field Construction Observation

The road on which the bridge was located was closed September 10, 2009 and the new bridge was completed September 14, 2009. Dirt work was completed for the approaches to the new bridge by county crews and required 14 days to complete. If necessary to open the road sooner, which wasn't the case with this project, the dirt work could have been bid out and completed quicker, reducing the number of days the bridge was closed.

Images showing the various phases of constructing the bridge are shown in Figures 2.16 through 2.19.

It took essentially one day to remove the existing bridge at the site. As shown in Figure 2.16a, the superstructure has been removed and all that remains at the east end of the bridge is the abutment and piling from the previous bridge at the site.

Templates used to position the five piles correctly in each abutment are shown in Figure 2.16b. When driving the piles, close attention had to be paid to their location and tolerances. Pile heads could not deviate from the specified locations by more than 3 in. in any direction, so that the precast pile cap could be installed easily.

Figure 2.16c shows the driving of the second pile in the west abutment, while Figure 2.16d shows all west abutment piling is in place and cut to the desired length. Driving of the final pile in the east abutment is shown in Figure 2.16e; also shown in this figure is the installed filter fabric.

It took only one day (September 11, 2009) to drive all 10 piles required for the bridge substructure. Arrival of the east pile cap is shown in Figure 2.16f; the installed abutment cap is shown in Figure 2.16g.



a. Existing east abutment



b. Piling templates



c. Pile driving in west abutment



d. Piling completed in west abutment



e. Driving piling in east abutment



f. East abutment cap arriving at site



g. East abutment cap in place



h. Installing west abutment cap

Figure 2.16. Abutment construction

The same process was repeated for installation of the west abutment cap, which is shown being positioned in Figure 2.16h. After installation of the two abutment caps, concrete was placed in the abutment voids on September 12, 2009 and allowed to cure over the weekend.

The superstructure and guardrail installations (except for approach guardrails) were completed in one day (September 14, 2009). The order of the precast beam placement is shown in Figure 2.17; as can be seen in the middle box beam (Bm #4) was placed first and the two exterior beams (Bms #1 and #7) were placed last.

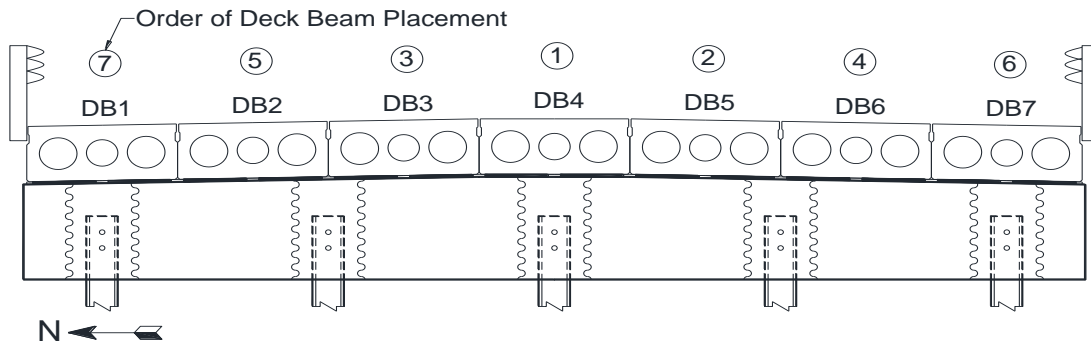

Figure 2.17. Order of box beam placement

Erection times for the various beams are presented in Table 2.3. Total time required for lifting beams from the seven trucks and placing them on the abutments was slightly less than an hour.

Table 2.3. Box beam erection times

Truck	Time Truck Arrived at Site	Beam Lifted from Truck	Beam Placed on Abutments	Time Required for Placement
1	7:35 a.m.	8:10 a.m.	8:32 a.m.	22 min
2	8:23 a.m.	8:35 a.m.	8:40 a.m.	5 min
3	9:12 a.m.	9:35 a.m.	9:40 a.m.	5 min
4	9:36 a.m.	9:50 a.m.	9:55 a.m.	5 min
5	9:37 a.m.	10:01 a.m.	10:05 a.m.	4 min
6	10:05 a.m.	10:15 a.m.	10:19 a.m.	4 min
7	11:11 a.m.	11:19 a.m.	11:25 a.m.	6 min
				Total = 51 min

Total time (from when the first truck arrived until the last beam was placed) was slightly less than four hours. The additional time was due to a problem with the depth of Bm #5 that delayed placement of Bm #3 and Truck #7 getting lost between the precast yard and the project site.

Two backwall sections were transported on Truck #4 and two on Truck #5. Upon arrival at the project site, they were unloaded and placed on dunnage until installation. Images of the various steps completed during the construction of the superstructure are shown in Figure 2.18. Details of the steps are described briefly in Table 2.4.



a. Both abutments in place



b. Unloading of Beam #4



c. Positioning of Beam #4



d. Setting of Beam #5

Figure 2.18. Construction of the superstructure



e. Difference in beam thickness



f. Positioning of Beam #3



g. Positioning of exterior Beam #7



h. Tie rod block out

Figure 2.18. Continued



i. Tightening interior tie rods



j. Drill hole in abutment cap for new anchor rods



k. Cutting off beam lift cables



l. Placement of non-shrink grout

Figure 2.18. Continued

Table 2.4. Key to images in Figure 2.18 and the various phases of bridge construction

Image	Description
a	Both the east and west abutment are ready for placement of the seven box beams. Some of the neoprene pads are in place as are the dowel ends for connecting the backwall segments to the abutment cap. In the background, the first truck with Bm #4 arrives.
b	Bm #4 is being lifted by two cranes and moved into position to be placed on the abutments.
c	Bm #4 is being placed (in the correct location longitudinally and transversely) on the neoprene pads.
d	Bm #5 is being put in place.
e	Due to a fabrication error, the north edge of Bm #5 was approximately 3/4 in. deeper than the desired depth of 21 in. Placement of the remaining beams was stopped until the county engineer reviewed this problem. Given this bridge was on a low-speed, low-volume road, the variation would not cause problems and construction continued. Except for this edge of Bm #5 all other beams were the desired 21 in. in depth.
f	Bm #3 has been lifted and is being positioned to place next to Bm #5.
g	Setting of the south exterior Bm #7 showing the extension of the anchor rods for attachment of the guardrail posts.
h	Voids in adjacent box beams (17 ft 1 in. from each end) created space so the coupling nuts required for the transverse tie assembly could be tightened. The exterior top prestressing tendon that is exposed will be covered when the grout between the adjacent units is placed and this void is filled.
i	Tightening of the transverse tie rods through the voids previously described in Figure 2.18h.
j	Workers using an impact rotary drill to create a 1 1/2 in. diameter hole 12 in. into the abutment cap. After the transverse tie assembly has been tightened, 1 1/2 in. smooth dowels (2 ft 3 in. long) will be epoxied in these holes.
k	Prior to grouting the various joints and voids in the bridge, the lifting loops were cut off slightly below the surface of the concrete deck. These regions were then filled with grout. Images of the several steps required for installing the backwalls and guardrails are shown in Figure 2.19 with a brief description of the construction in Table 2.5.
l	Workers shown placing non-shrink, non-metallic grout (NS Grout manufactured by The Euclid Chemical Company) in the joints between the adjacent beams and the pockets required for tightening the transverse tie assembly. Prior to placement of the grout, polystyrene backer rod was placed in the joint where required. Note the joint between Beams 6 and 7 has been completed and has been covered with wet burlap for curing.

Details on the installation of the backwalls and guardrails are presented in Figure 2.19 and Table 2.5.



a. Removing lifting loops on backwall segments



b. Placing grout bed for backwall segment



c. Placement of a backwall segment



d. Placement of second backwall segment at west end

Figure 2.19. Installation of precast backwalls and guardrail system



e. Grouting of various voids and joints



f. Completing north guardrail



g. Installation of guardrail post on south side of bridge



h. "Completed" bridge

Figure 2.19 Continued

Table 2.5. Key to images in Figure 2.19 and the various phases of backwall and guardrail construction

Image	Description
a	Prior to placing the backwall segments on the abutments, the lifting loops used in removing the elements from the forms, placing them on the trucks for shipping, etc., were removed. The segments were then moved using lifting hooks, screwed into inserts precast into their top surface.
b	As may be seen, for leveling the backwall segments and connecting them to the abutment cap, an epoxy grout bed was first placed. Prior to this step, the backwall segments were dry-fitted on the abutment dowels to ensure a proper fit.
c	One of the two backwall segments required at each end of the bridge is being placed on the epoxy grout bed.
d	After placing the first backwall segment, the second one was set on the epoxy grout bed. Similar to the first one, it also was dry-fitted to make sure of it fitting correctly with the other backwall segment and the abutment dowels.
e	After the four backwall segments were placed, the various voids (between the box beams, in the backwall wall segments, between the backwall segments and box beams, etc.) were grouted and cured.
f	After completing the superstructure, the guardrails (the portion attached to the box beams) were installed. This image shows installation of the last section of the guardrail on the north side of the bridge.
g	Installation of the guardrail posts on the south side of the bridge.
h	The bridge was essentially complete on September 24, 2009 except for the required approaches and remaining portions of the guardrails.

A Sony internet-based web-camera was installed relatively close to the northeast corner of the bridge site as shown in Figure 2.20a. A close-up of the camera is shown in Figure 2.20b.

This camera was installed on September 8, 2009 and recorded an image of the construction site every 5 minutes until September 15, 2009 when the camera was removed.

Images during this time period have been merged and provide a continuous record of the removal of the original bridge and construction of the new one. This time-lapse record may be obtained from the researchers.



a. Camera installation



b. Time-lapse camera

Figure 2.20. Time-lapse camera at bridge site during bridge construction

3. FIELD TESTING

Field testing of the BVC precast bridge took place in 2009 (September 14) and 2010 (October 19) so that any behavior changes in this 13 month period could be quantified. In the following sections, instrumentation and the test methodology used are presented. In the next chapter, results from the two tests are presented.

3.1. Instrumentation

The BEC in conjunction with BVC and the Iowa DOT developed the monitoring and evaluation plan for the bridge. The plan entailed investigating the behavior of the bridge after its completion and its behavior approximately one year later. Instrumentation was placed at important locations to measure overall deflections, relative deflections between adjacent box beams, and strains. The location of the instrumentation used for the two tests is shown in Figure 3.1 (2009 instrumentation in Figure 3.1a and 2010 instrumentation in Figure 3.1b).

Based on results from the 2009 tests, slightly less instrumentation was used in the 2010 tests. In the 2009 tests, 24 Bridge Diagnostics Inc. BDI transducers were used for measuring strains at desired locations and 12 displacement transducers were used for measuring deflections at desired locations. The arrangement of deflection transducers made it possible to measure global displacements of the bridge as well as relative displacements between adjacent box beams. In 2010, relative displacement transducers (shown in Figure 3.2) were used, given it was desired to determine the relative displacement between adjacent box beams rather than global displacements.

3.2. Testing

As noted previously, the bridge was tested two times with the tests being approximately 13 months apart. In both years, the testing consisted of point-in-time live load testing with either a fully-loaded three-axle dump truck or two fully-loaded three-axle dump trucks being positioned on the bridge.

A total of seven load cases, shown in Figure 3.3 (LC1 through LC7), in which the transverse position of the truck(s) was varied, were used in 2009. Note that in LC6 and LC7, there were two trucks on the bridge. In the 2010 tests, the same load cases (shown in Figure 3.3) were used, except that LC6 was omitted.

The dimensions and weights of the test trucks used each year are presented in Figure 3.4. Truck 28 was used both years and was the truck used in the single truck load cases (LC1-LC5). Based on total weight, the weight of the truck was approximately the same each year; however, there was some difference in the axle weight distribution.

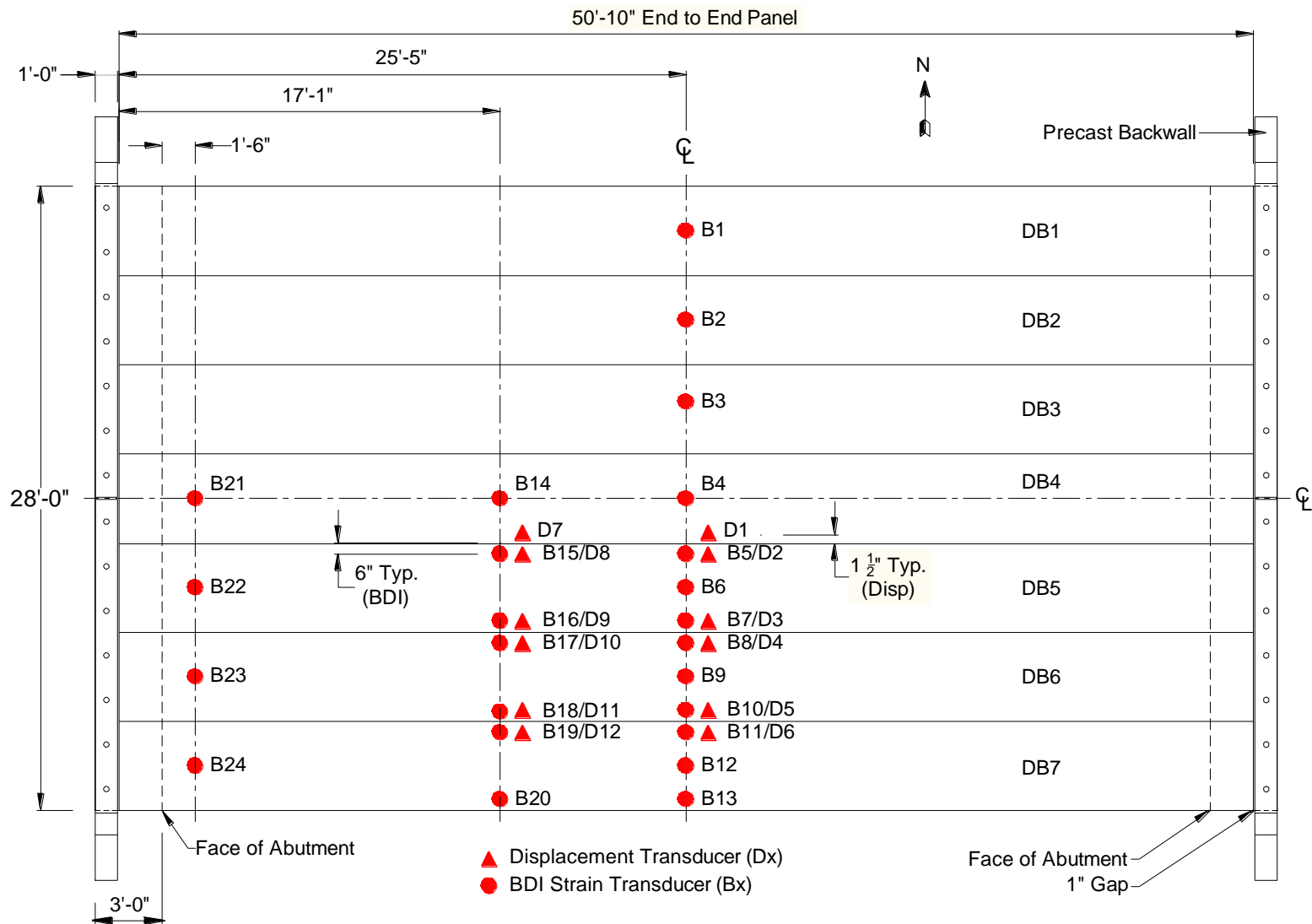

a. 2009 Instrumentation

Figure 3.1. Instrumentation layout

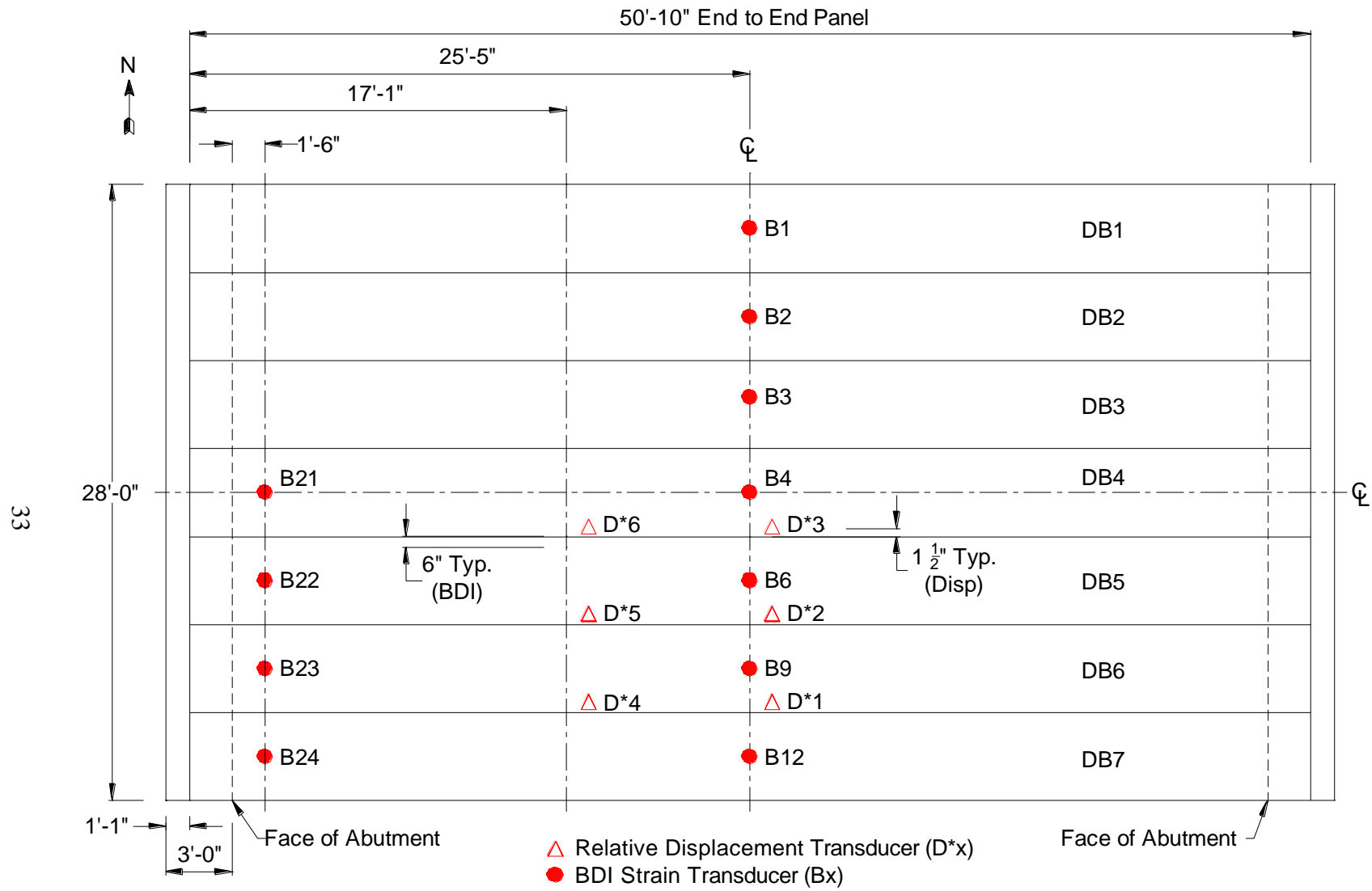

b. 2010 Instrumentation

Figure 3.1. Continued



Figure 3.2. Relative displacement transducer between DBs 5 and 6

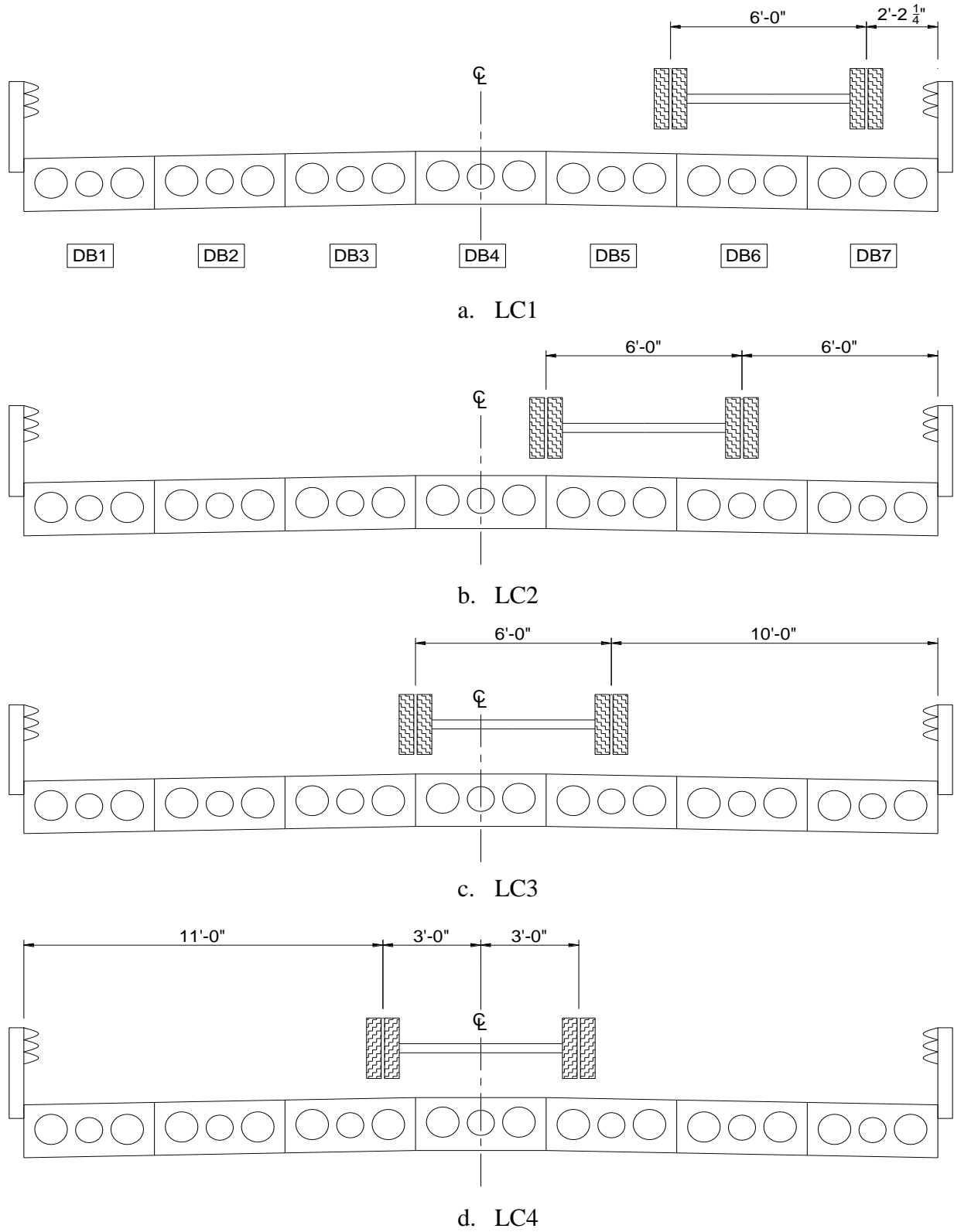
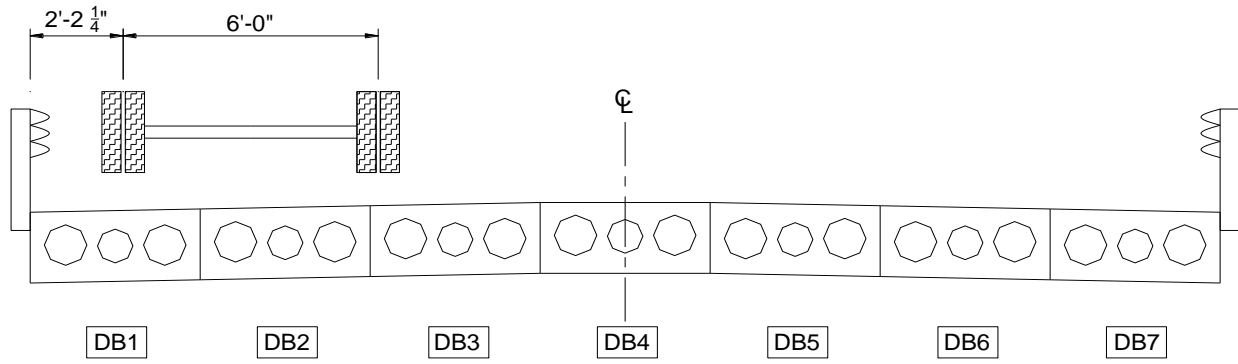
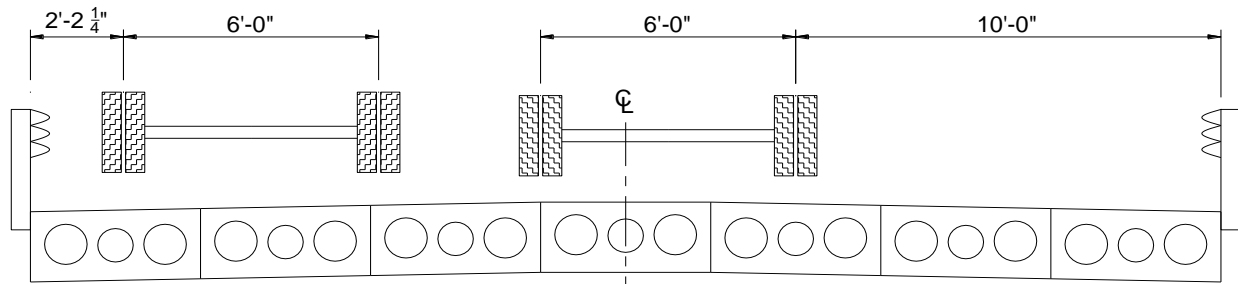

Figure 3.3. Transverse load positions: vehicle traveled east (into page)



e. LC5



f. LC6 [summation of LC3 + LC5]

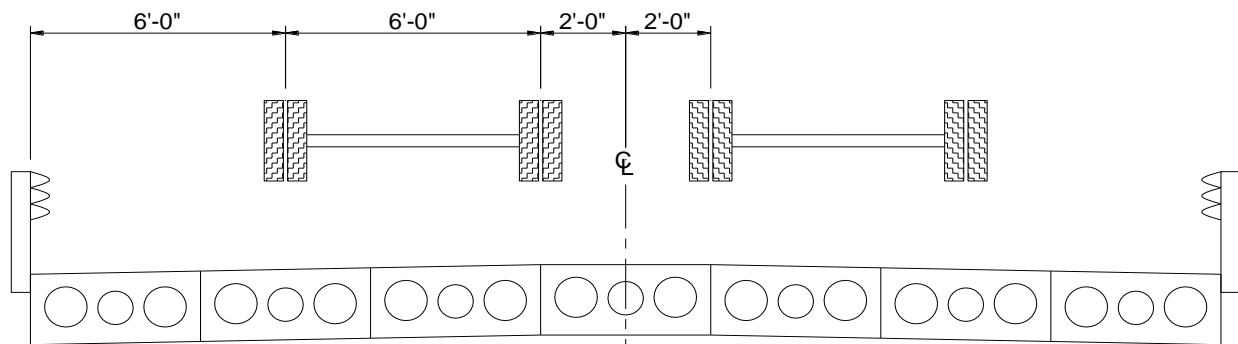

g. LC7

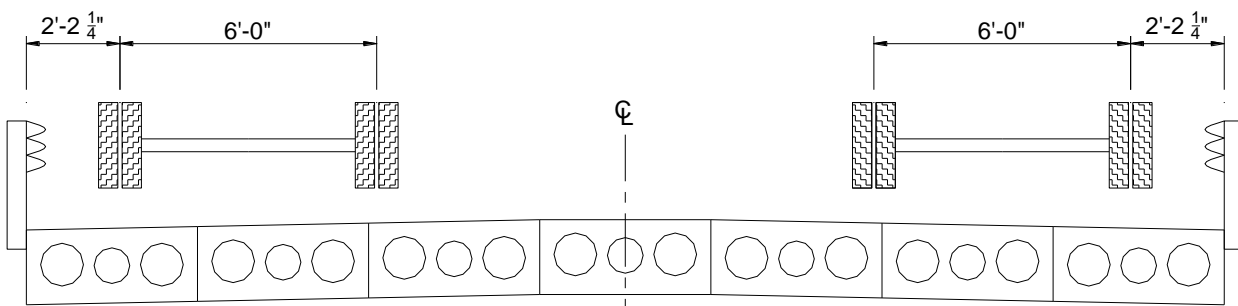

h. LC8 (2009, 2010: [summation of LC1 + LC5])

Figure 3.3. Continued



a. Truck 28



b. Truck 13 (same as Truck 12)

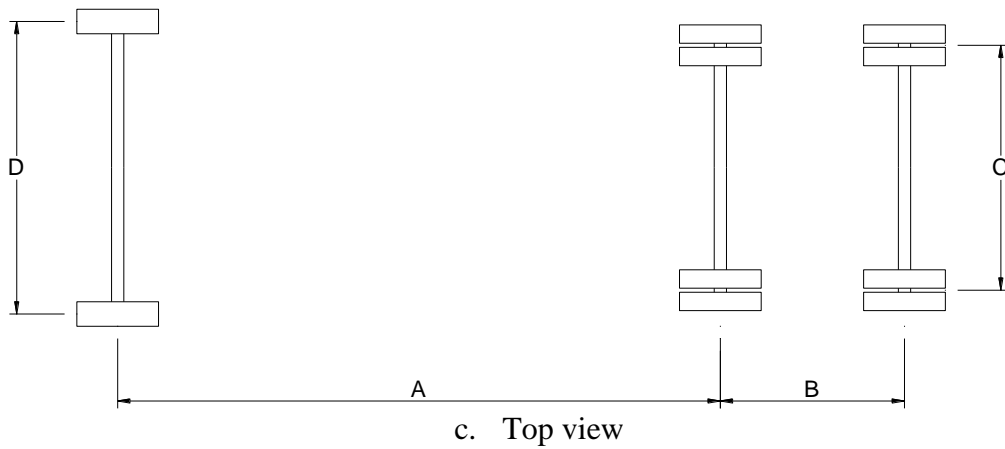

c. Top view



d. Side view

Year	Truck	Dimensions				Load (lbs)		
		A	B	C	D	F	T	Gross
2009	28	14'-9"	4'-6"	6'-0"	7'-2"	18,800	38,140	56,940
	13	15'-2"	4'-5"	6'-0"	7'-2"	17,600	37,820	55,420
2010	28	14'-9"	4'-6"	6'-0"	7'-2"	17,000	39,340	56,380
	12	15'-2"	4'-5"	6'-0"	7'-2"	17,540	41,000	58,540

Figure 3.4. Dimensions and weights of test trucks used in 2009 and 2010 bridge field tests

In 2009, Truck 13 was the second truck on the bridge in LC6 and LC7, while, in 2010, Truck 12 was used with Truck 28 in the two truck load tests (LC7). As Figure 3.4 shows, Truck 12's weight (used in the 2010 test) was about 3,000 lbs greater than Truck 13 (used in the 2009 test); however, the axle spacing in the two trucks is the same. An image of the two trucks on the bridge during LC7 in 2010 is shown in Figure 3.5.



Figure 3.5. Trucks on bridge during 2010 LC7 test

4. FIELD TEST RESULTS

Field testing of the BVC precast bridge took place in 2009 and 2010 so that any behavior changes in this time period could be reviewed. In the following sections, static test results from these two tests are reviewed and in some cases compared.

4.1. Loading Cases

As noted previously, only static tests were performed (slow moving truck when one truck was on the bridge and stationary trucks when two trucks were on the bridge) each year on the bridge. In Figure 3.3, eight load cases are shown: five cases with one truck on the bridge and three cases with two trucks on the bridge. In 2010, LC6 was not ran and results for this load case were obtained by adding the results from 2010 LC3 and LC5.

The various load cases were selected to maximize deflections and strains in various elements of the bridge and to meet the goals of the project. All trucks crossed the bridge traveling west to east. Data from the various tests were used to determine maximum box beam strains, bridge global deflections (2009 only), box beam differential deflections, load fractions, and end fixity.

4.1.1. Bridge Deflections

As a result of the small global deflections measured during the 2009 tests, it was decided to measure only differential deflections between the adjacent box beams in the 2010 tests. The maximum measured box beam deflection for the various load cases investigated in 2009 are shown in Table 4.1.

Table 4.1. 2009 Maximum midspan girder deflection

Deflection	Load Case							
	LC1	LC2	LC3	LC4	LC5	LC6	LC7	LC8
Magnitude (in.)	0.183	0.151	0.144	0.143	0.100	0.242	0.259	0.250
Location	DB7	DB6	DB5	DB4	DB4	DB4	DB4	DB7
Gage	(D6)	(D4)	(D2)	(D1)	(D1)	(D1)	(D1)	(D6)

In all load cases, with the truck(s) (traveling east), the data presented are with the centerline of the tandem wheels positioned at the centerline of the bridge. Recall in LC1-LC5 there was only one truck on the bridge, while in L6-L8, there were two trucks on the bridge. With one truck on the bridge, the maximum deflection (0.183 in.) occurred in deck beam DB7 during LC1; with two trucks on the bridge, the maximum deflection (0.259 in.) occurred in deck beam DB4 during LC7.

The code serviceability limit state for deflection is $L/800$ for a bridge loaded with two HS20 trucks including a dynamic amplification factor (AASHTO 2007, 1996). The limit state corresponds to a maximum deflection of approximately 0.75 in.

As noted previously, the maximum deflection (0.259 in.) occurred during LC7; when this value is normalized by weight to the standard HS20 truck and a dynamic amplification factor of 30 percent is used, the maximum deflection becomes 0.479 in., which corresponds to a span to deflection ratio of $L/1253$. The BVC deck beam bridge, therefore, is well within the AASHTO serviceability limit state for deflection.

Representative time-history deflections for 2009 LC1, LC2, and LC7 are presented in Figure 4.1.

The various time history plots show deflections at midspan and quarter span at the edges of deck beams DB4, DB5, DB6, and DB7. With these data, the differential deflection between the four deck beams can be determined. A review of this deflection data indicates the differential movement between the adjacent deck beams for LC2 and LC7 is very small. In general, the deck beams that had the largest deflections were located closest to the applied load.

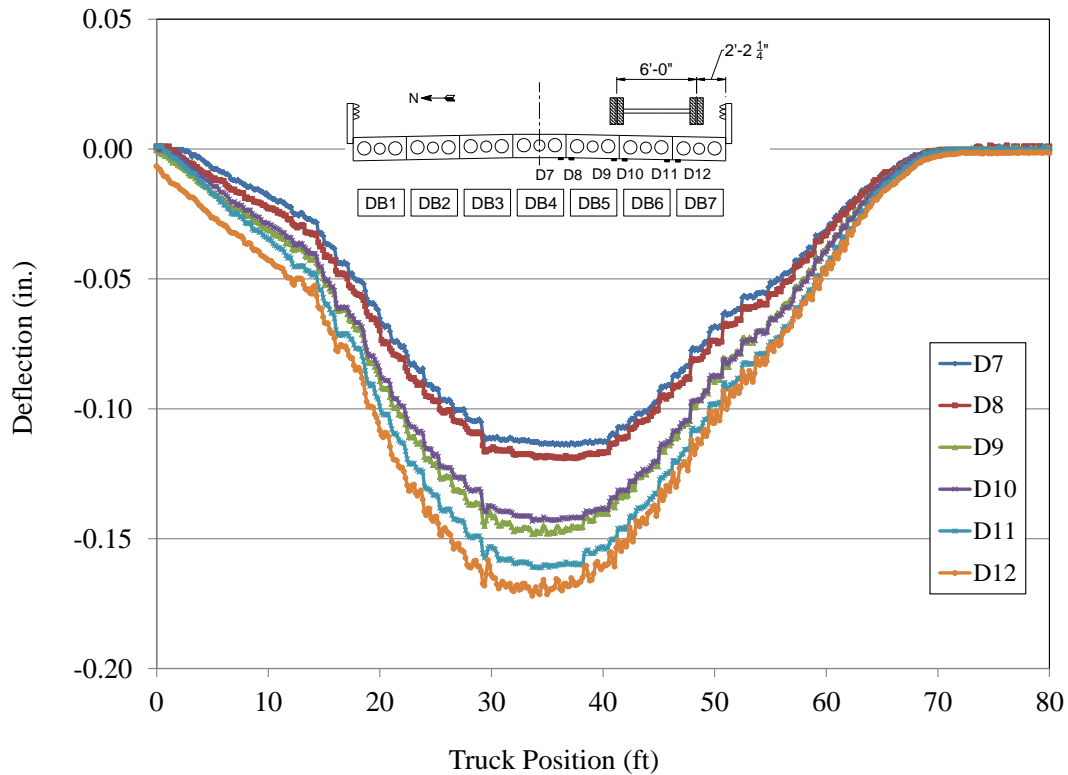

a. LC 1 – Quarterspan

Figure 4.1. Representative time history – 2009 deflections

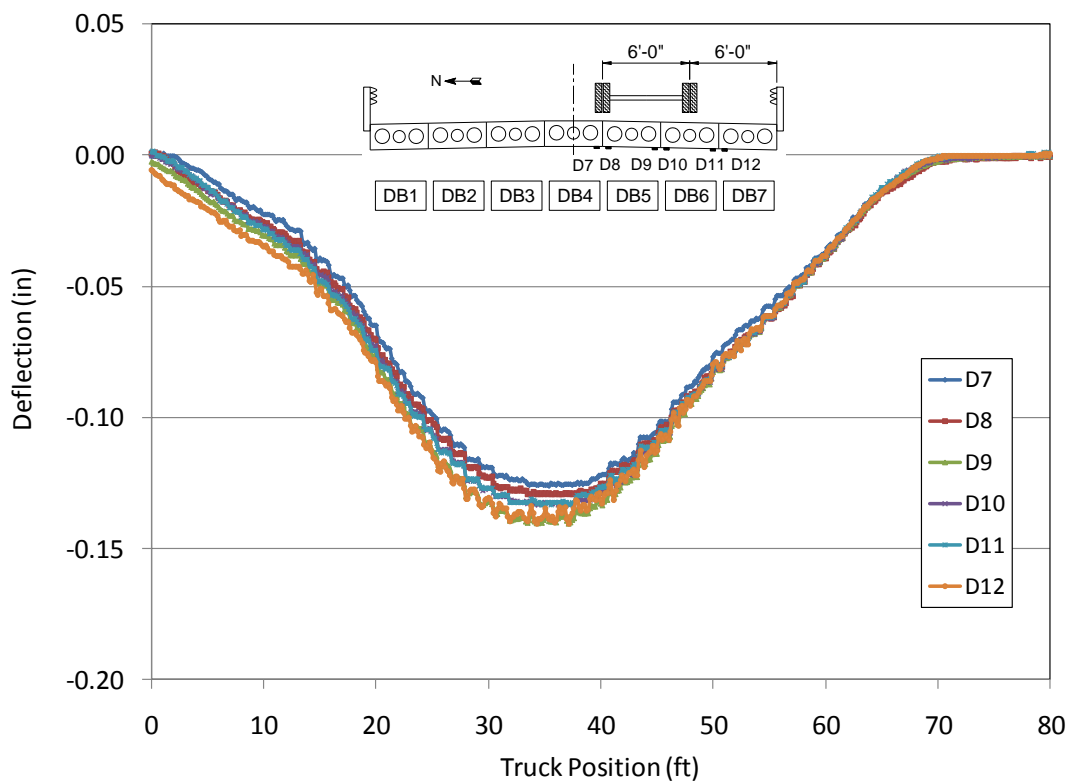
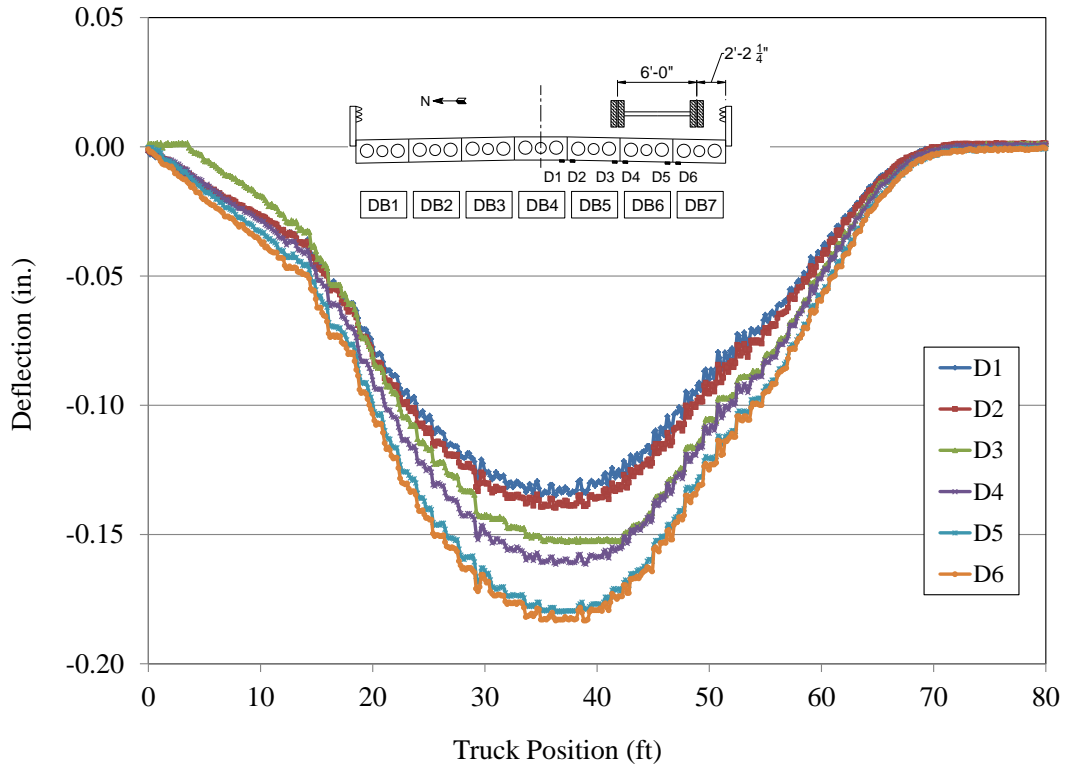

Figure 4.1. Continued

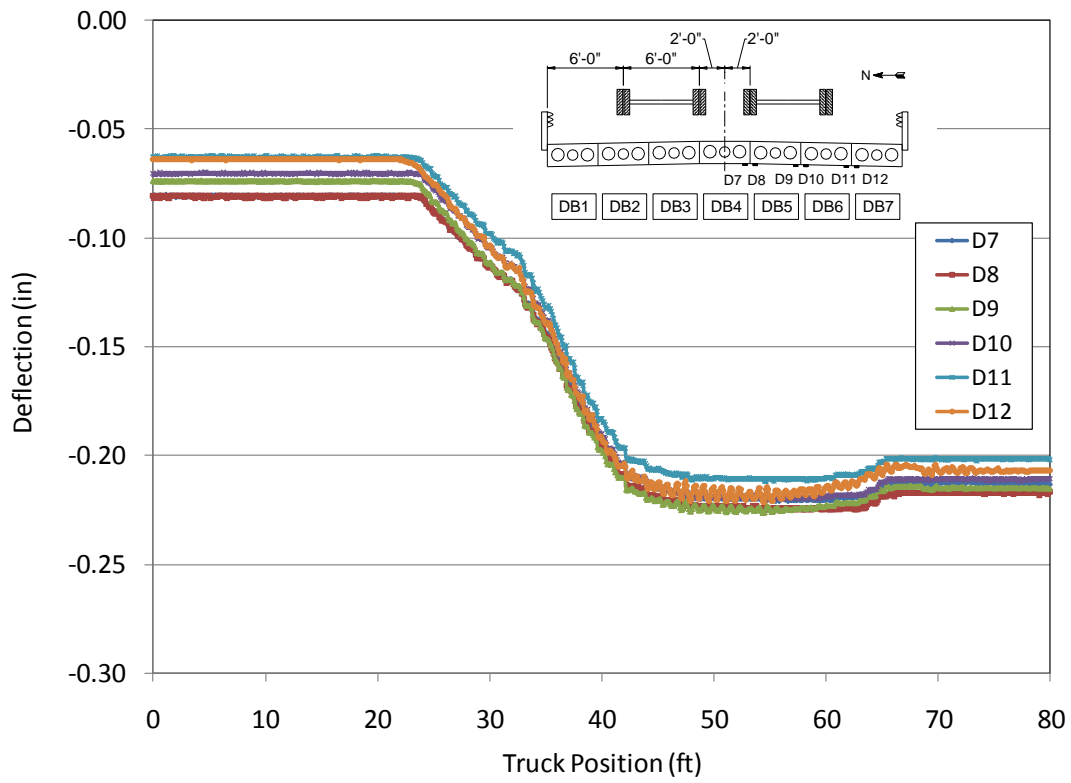
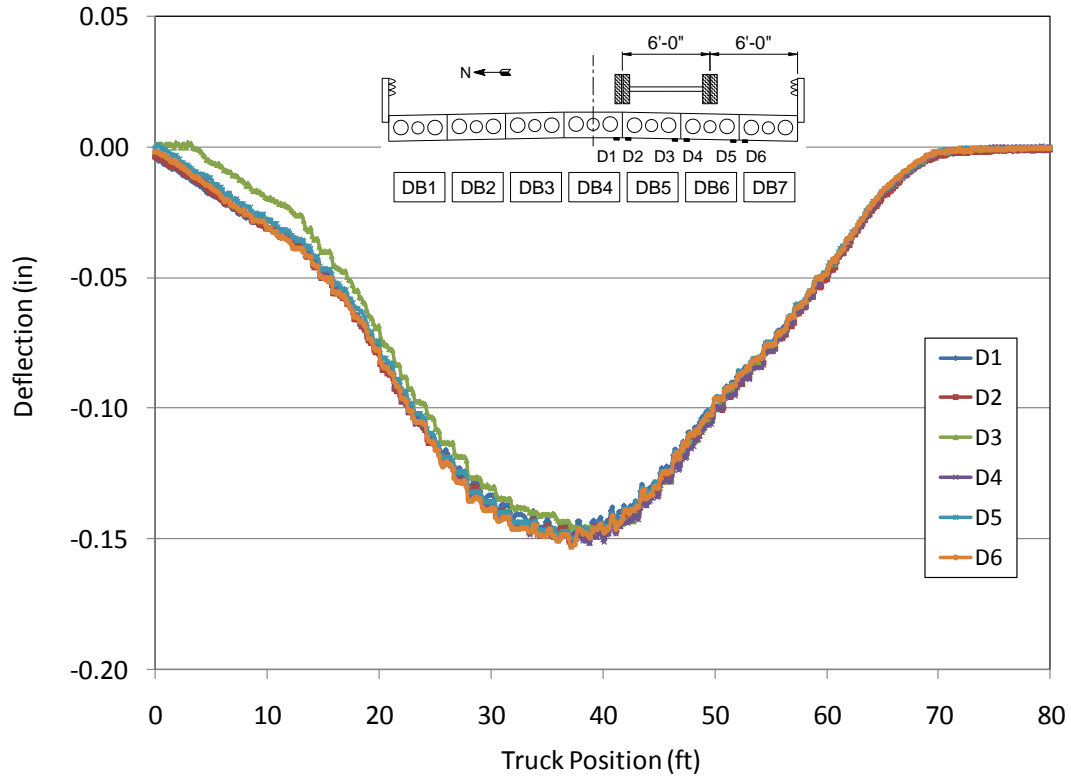
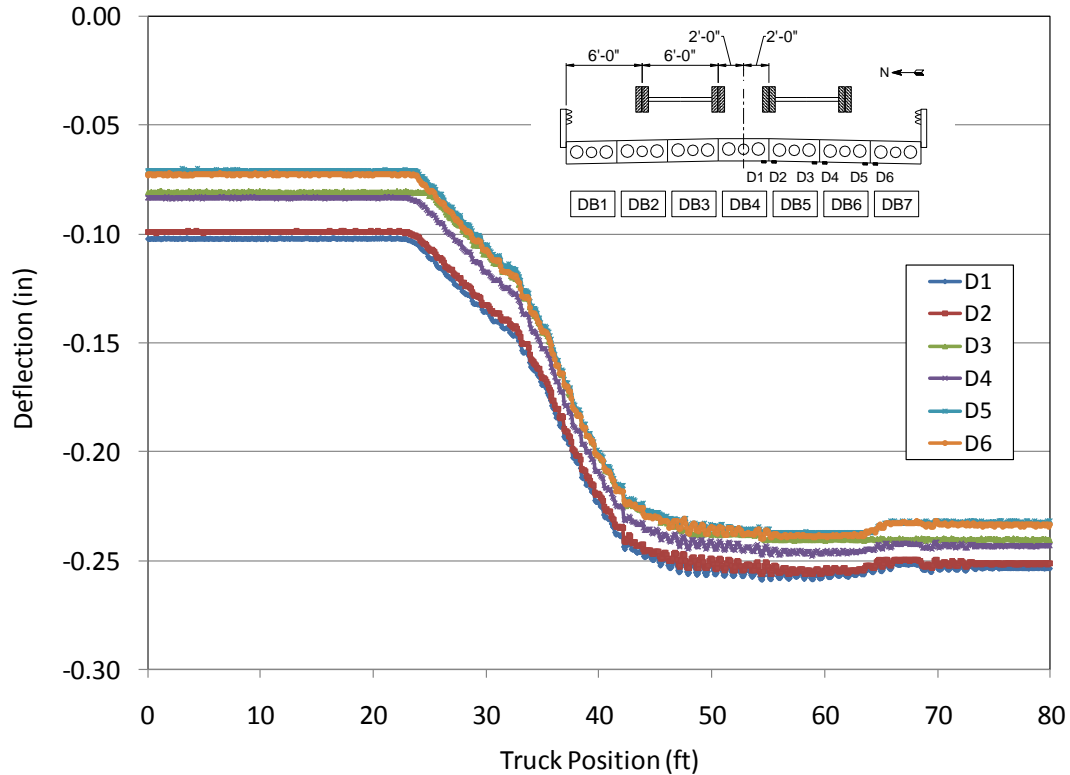

Figure 4.1. Continued



f. LC 7 – Midspan
Figure 4.1. Continued

Partial (since displacements were only measured on one-half of the bridge) transverse deflections for the same three load cases (LC1, LC2, and LC7) are presented in Figure 4.2.

As noted previously, LC1 and LC7 produced the maximum deflections for one and two trucks, respectively. Transverse load distribution is evident as shown in this figure, as the deck beams adjacent to directly-loaded deck beams also deflect, creating a continuous deflected shape. Although not the actual behavior, for illustration, the various deflection points have been connected with straight lines.

Figures 4.3 and 4.4 are included to show how the differential movement between DB4 and DB5, DB5 and DB6, and DB6 and DB7 varied as the test vehicle crossed the bridge.

Differential movements that occurred during the 2009 load tests for LC1, LC2, and LC7 (representative load cases), at the quarterspan and the midspan are presented in Figure 4.3. Maximum values shown in these figures are presented in Table 4.2.

As was noted previously, the differential movements measured during the bridge test in 2010 were very small (approximately 1/10 the values measured during the 2009 tests. For this reason, only the 2010 differential movements measured during one load case, LC1, are presented in this report (see Figure 4.4).

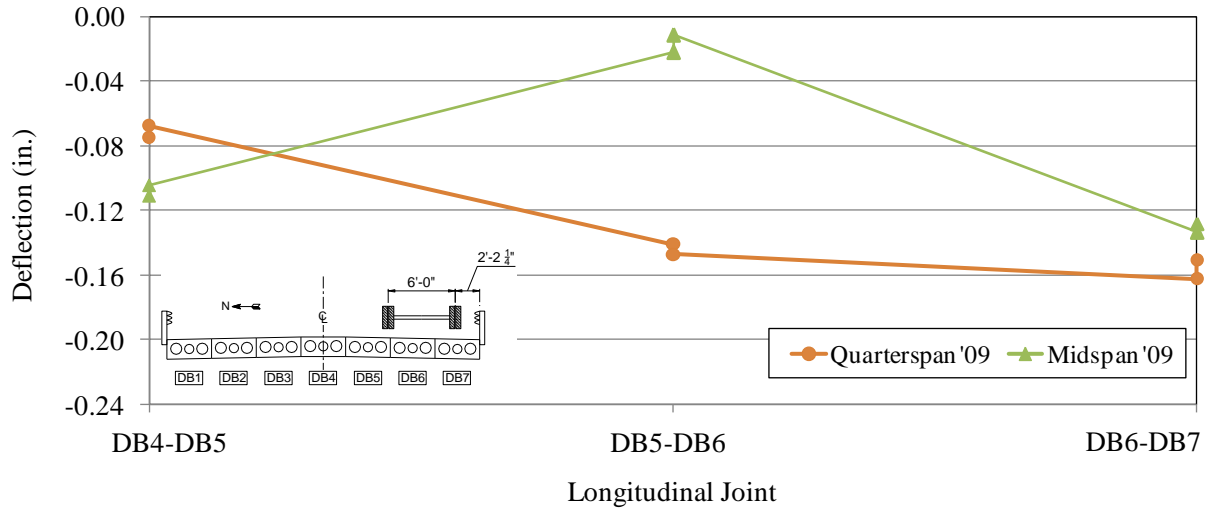

a. LC1

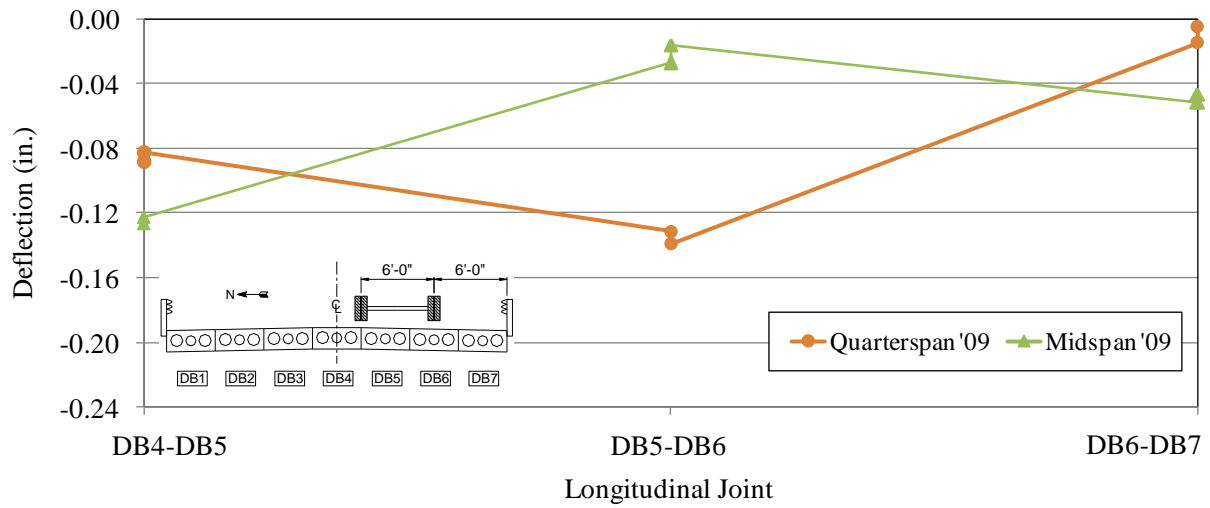

b. LC2

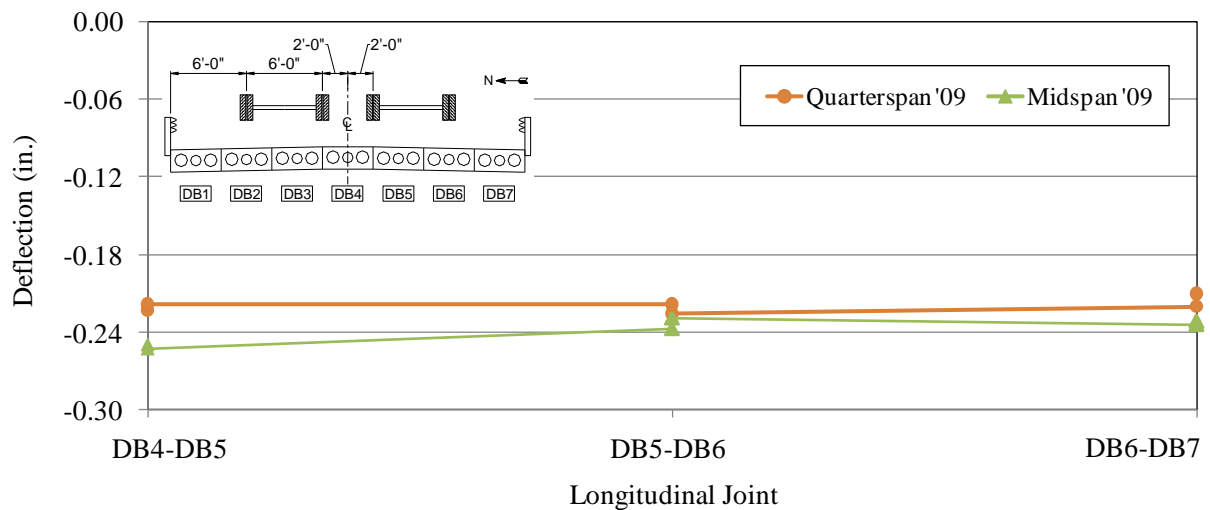

c. LC7

Figure 4.2. 2009 Transverse deflected shape at midspan and quarterspan

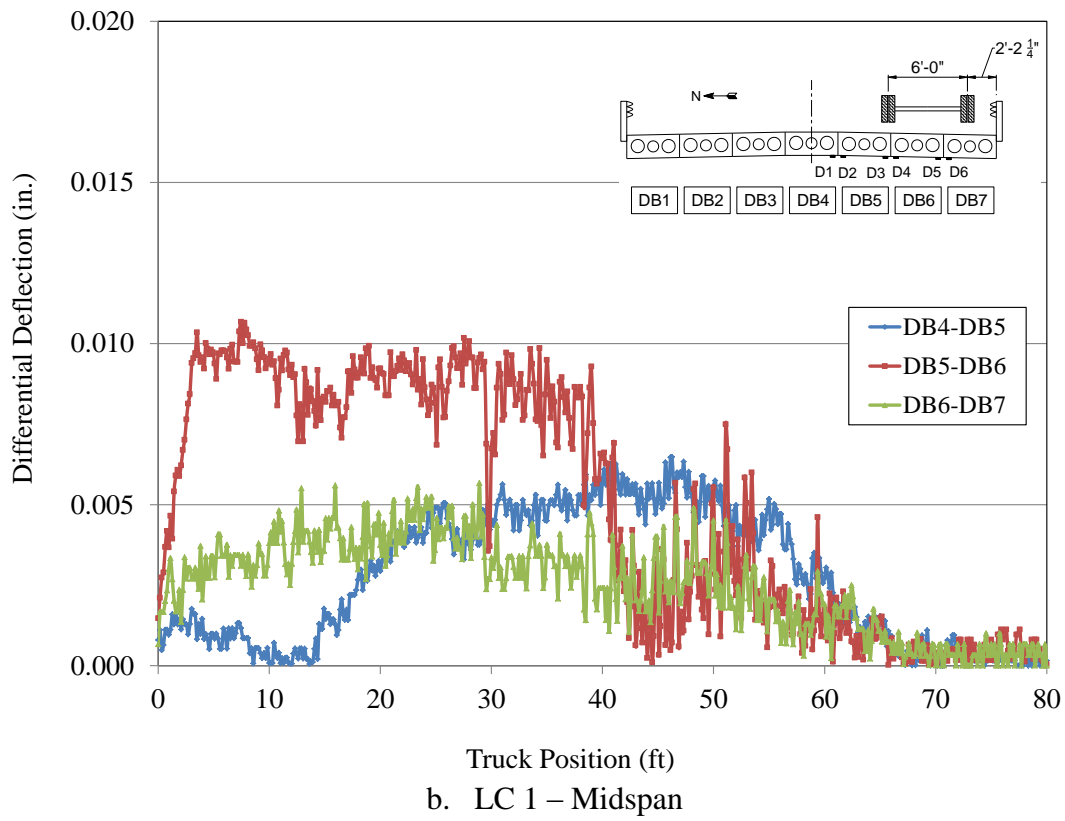
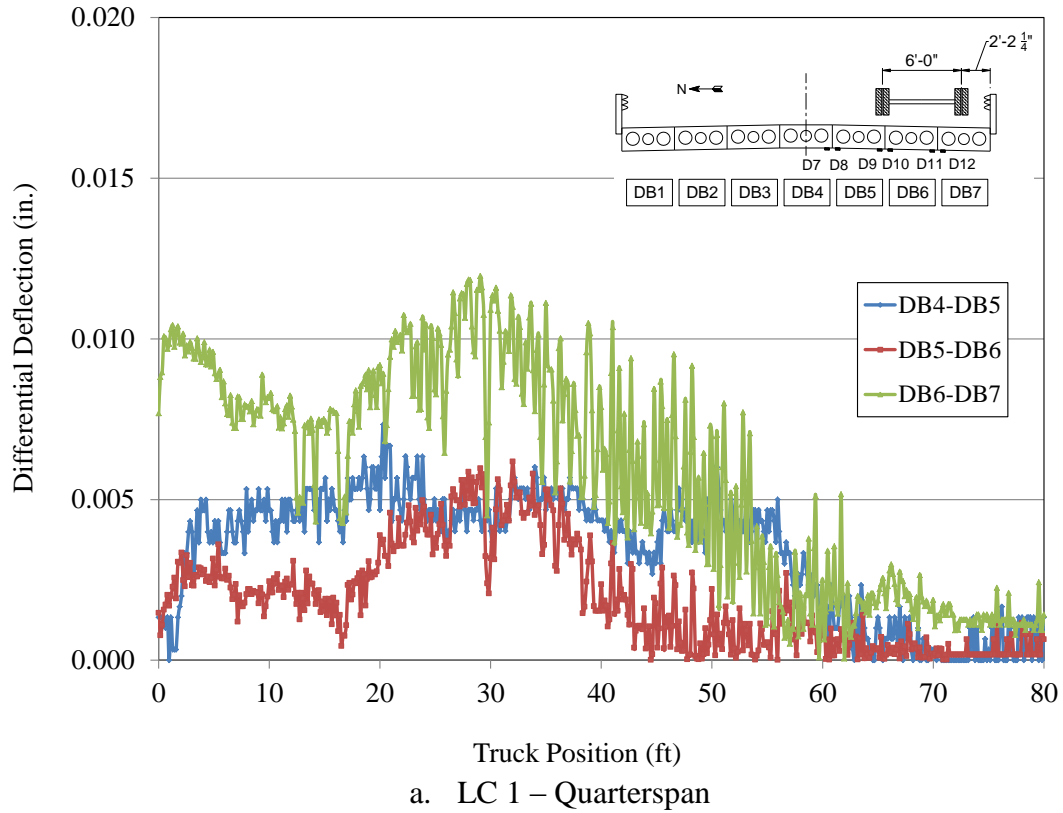
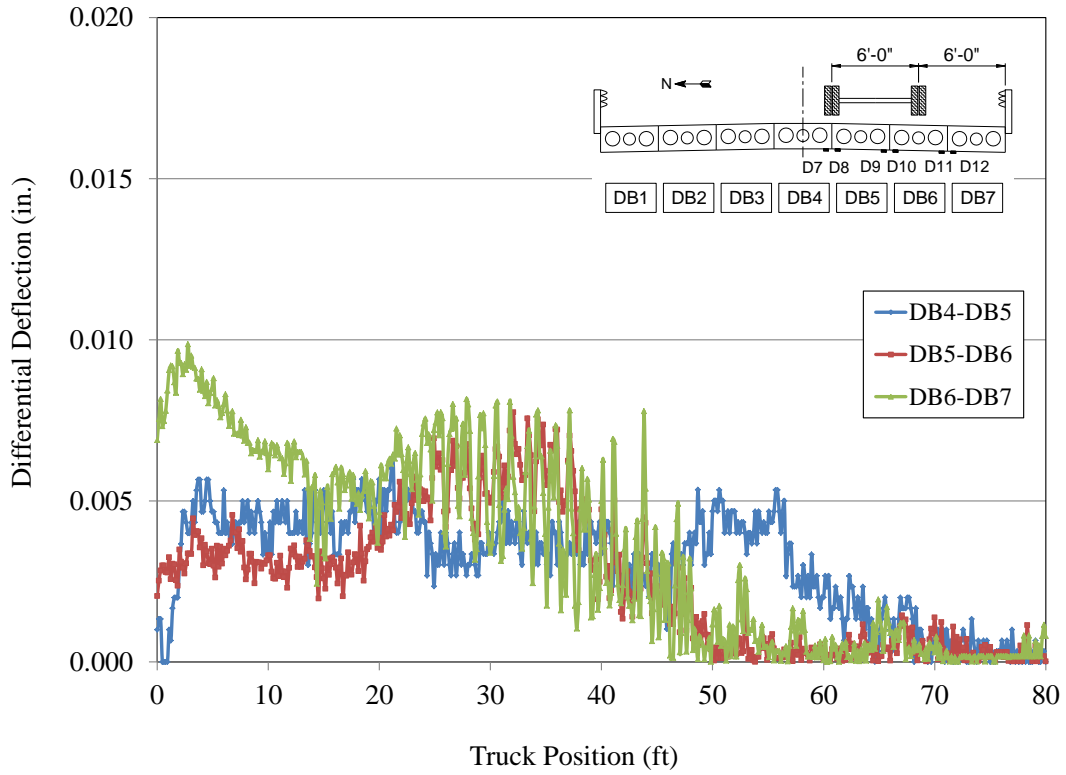
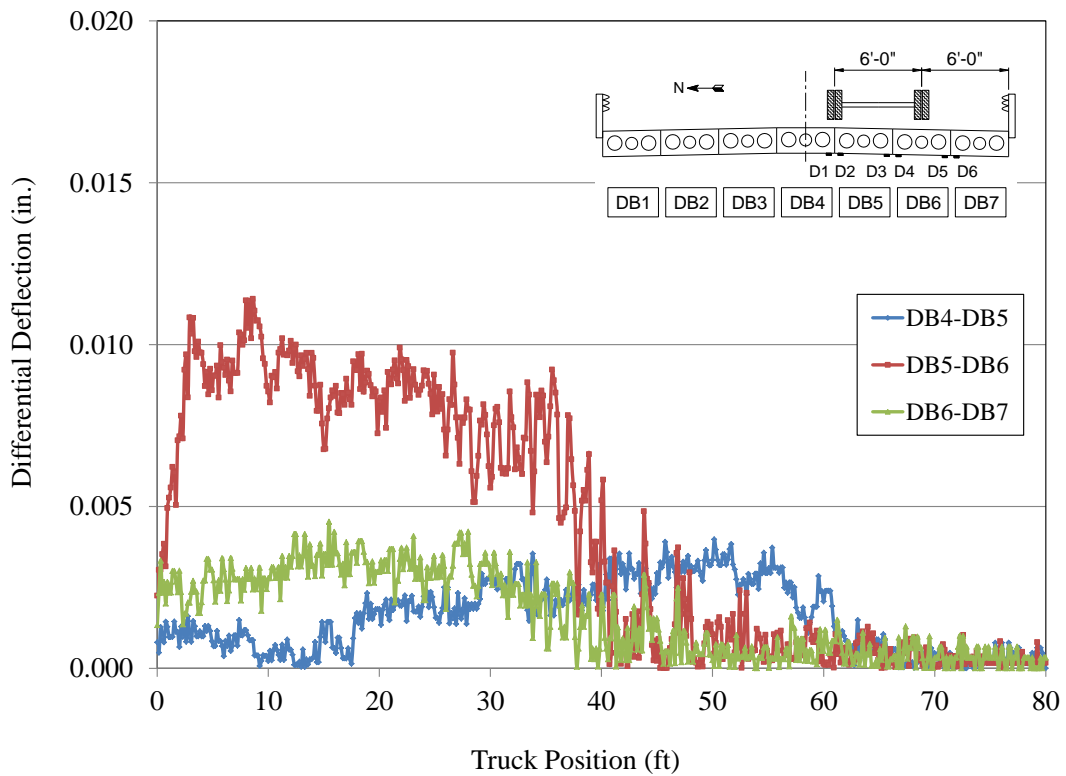

Figure 4.3. Representative time history differentials



c. LC 2 – Quarterspan



d. LC 2 – Midspan

Figure 4.3. Continued

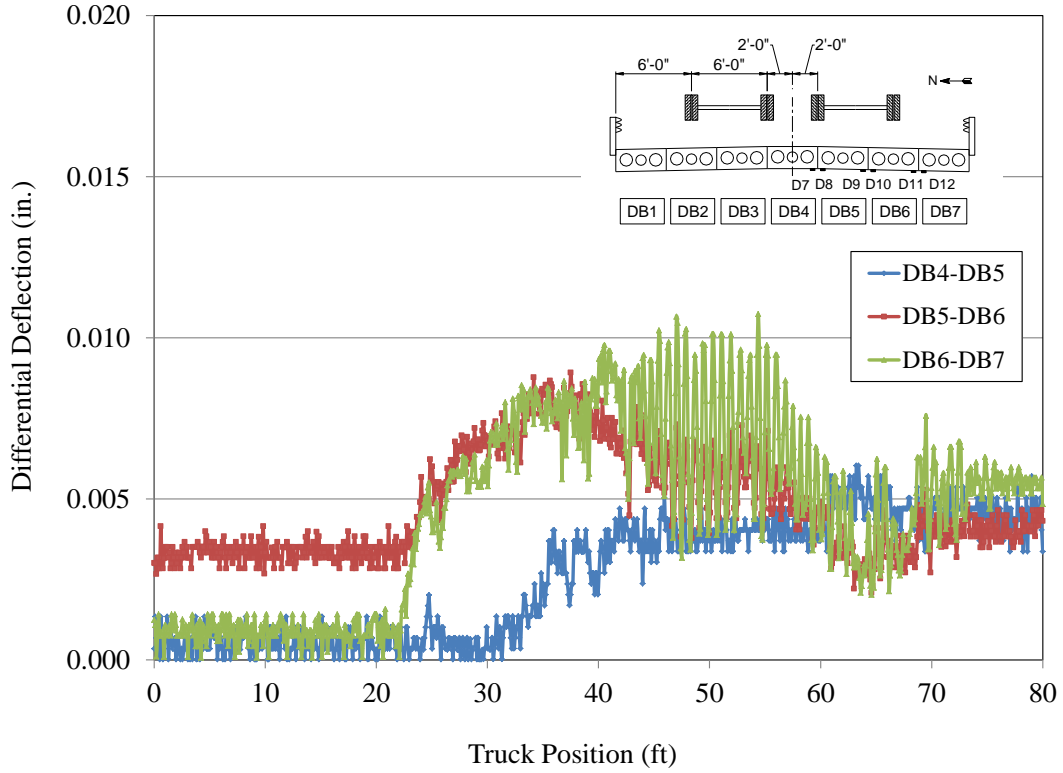

e. LC7 – Quarterspan

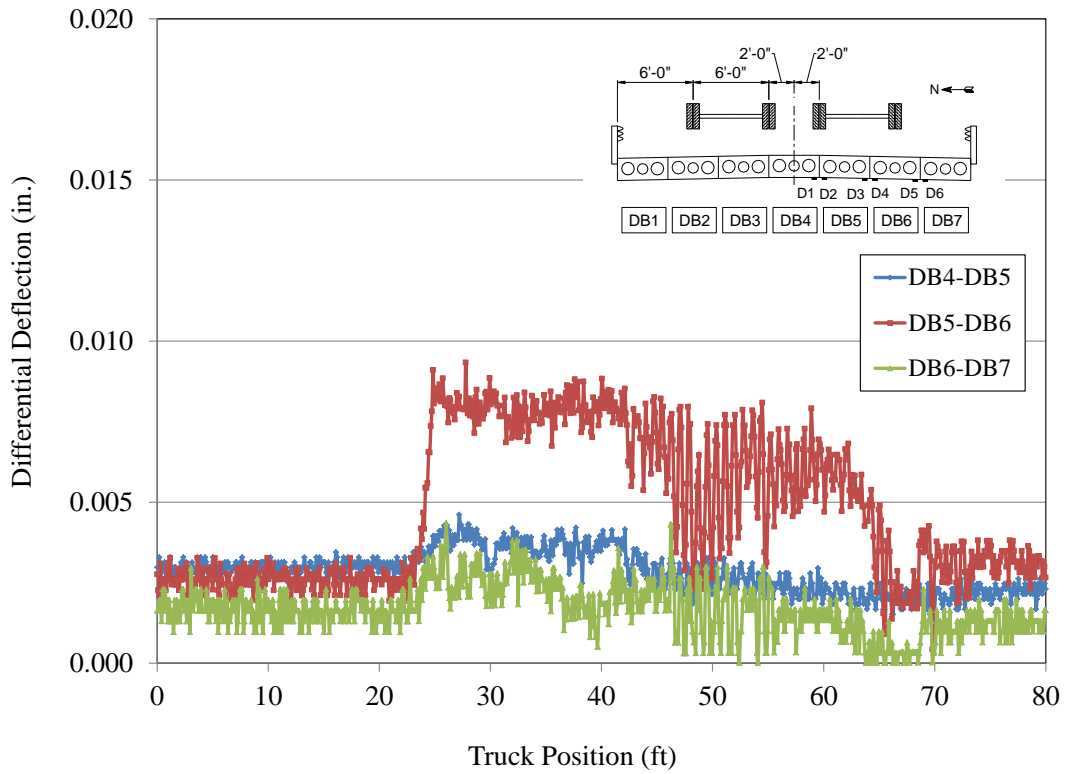

f. LC7 – Midspan

Figure 4.3. Continued

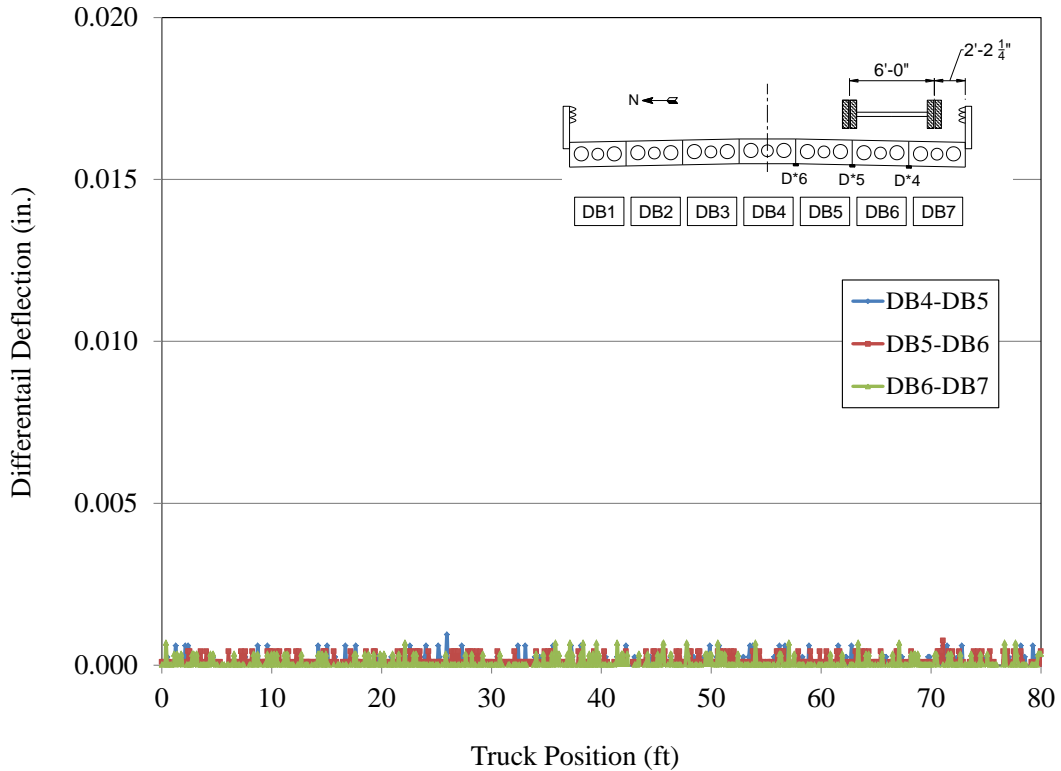

a. LC 1 – Quarterspan

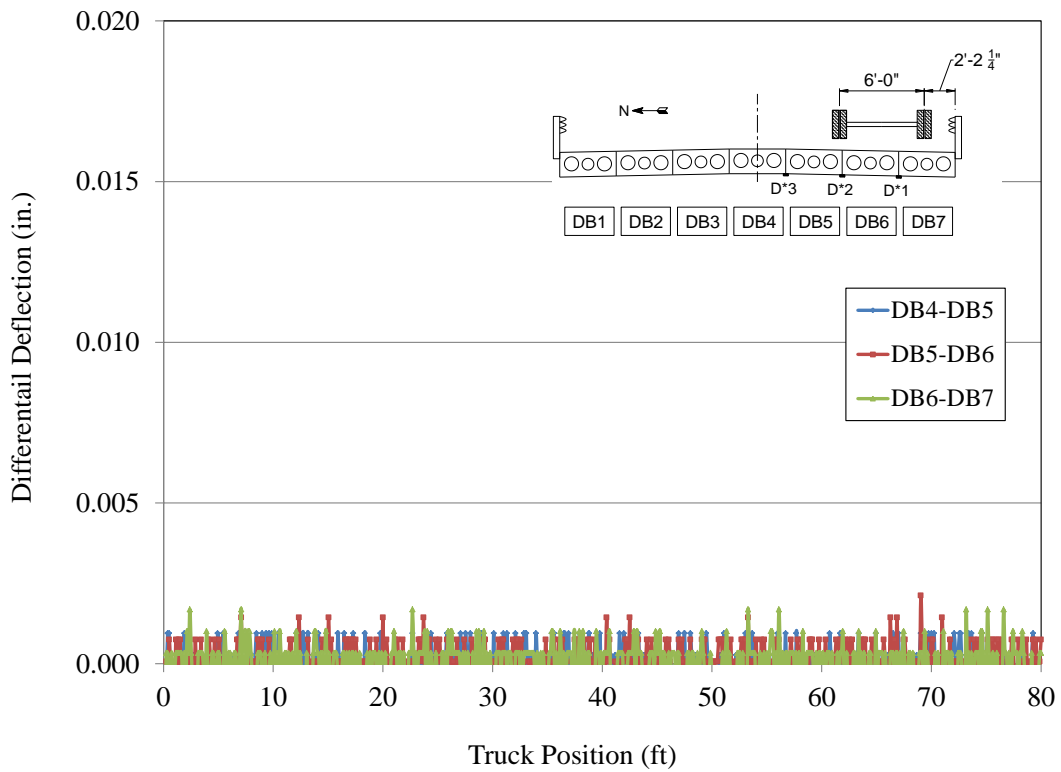

b. LC 1 – Midspan

Figure 4.4. Representative time history – 2010 differentials

Table 4.2. 2009 Maximum differential movement

	Maximum Differentials (in.)					
	Quarter Span			Center Span		
Beam Gap	DB4-DB5	DB5-DB6	DB6-DB7	DB4-DB5	DB5-DB6	DB6-DB7
Gage Pair	D7-D8	D9-D10	D11-D12	D1-D2	D3-D4	D5-D6
LC1	0.007	0.006	0.012	0.006	0.011	0.006
LC2	0.006	0.008	0.010	0.004	0.011	0.005
LC3	0.005	0.008	0.009	0.002	0.012	0.004
LC4	0.005	0.008	0.010	0.002	0.011	0.004
LC5	0.005	0.005	0.010	0.005	0.011	0.005
LC6	0.009	0.012	0.018	0.005	0.021	0.007
LC7	0.006	0.009	0.011	0.005	0.009	0.004
LC8	0.010	0.010	0.018	0.010	0.021	0.010

As was the case for the 2009 load tests, the maximum values shown in these figures, as well as the maximum values for the other seven load cases, are presented in Table 4.3.

Table 4.3. 2010 Maximum differential movement

	Maximum Differentials (in.)					
	Quarter Span			Center Span		
Beam Gap	DB4-DB5	DB5-DB6	DB6-DB7	DB4-DB5	DB5-DB6	DB6-DB7
Gage Pair	D6	D5	D4	D3	D2	D1
LC1	0.0009	0.0008	0.0007	0.0010	0.0021	0.0017
LC2	0.0010	0.0010	0.0006	0.0013	0.0011	0.0021
LC3	0.0007	0.0008	0.0012	0.0008	0.0014	0.0012
LC4	0.0007	0.0005	0.0007	0.0014	0.0021	0.0023
LC5	0.0010	0.0007	0.0010	0.0015	0.0018	0.0022
LC6	0.0014	0.0012	0.0015	0.0016	0.0025	0.0027
LC7	0.0010	0.0009	0.0010	0.0015	0.0025	0.0019
LC8	0.0009	0.0013	0.0008	0.0018	0.0016	0.0020

Figure 4.5 presents the absolute maximum differential deflections at midspan and quarterspan for each of the 2009 and 2010 load cases. Given the differential deflections were so small and the variation in truck weights from year to year were also small, direct comparison of differential displacements were made without normalizing for the truck weight differences.

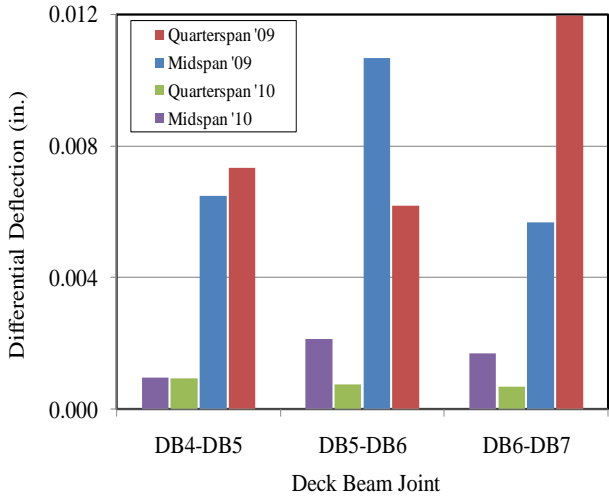

a. LC1

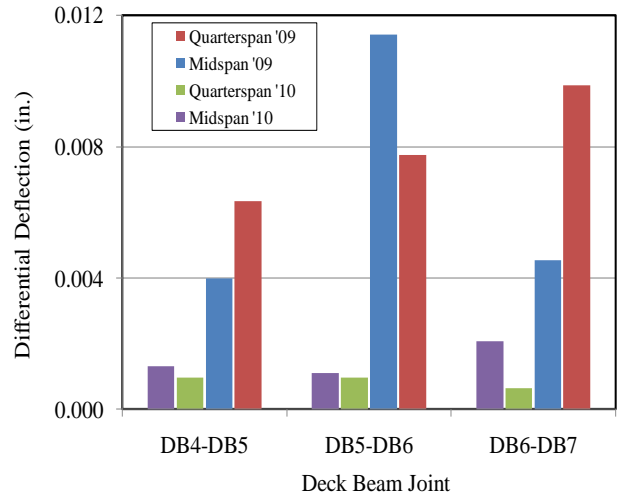

b. LC2

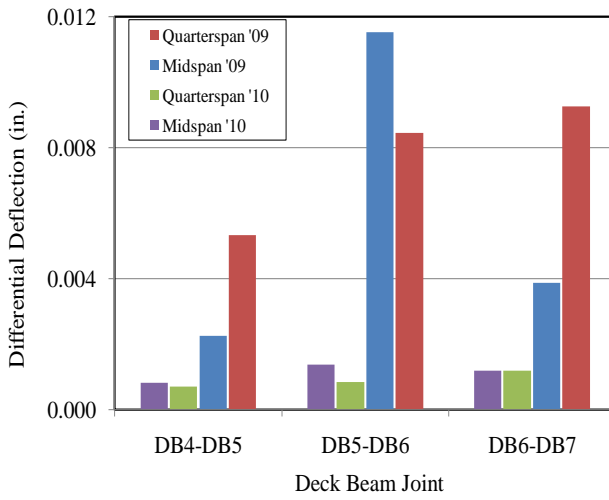

c. LC3

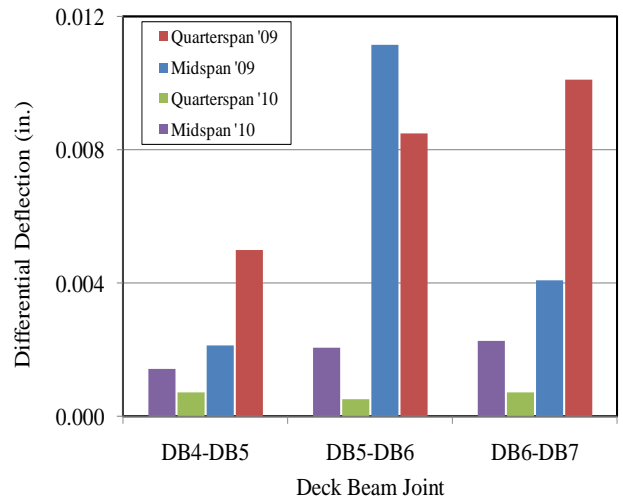

d. LC4

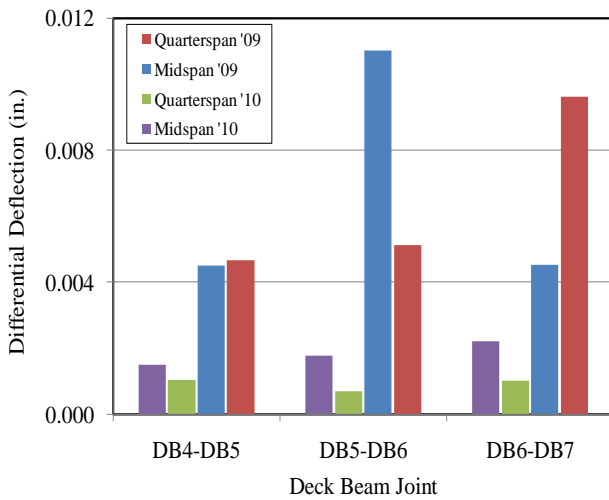

e. LC5

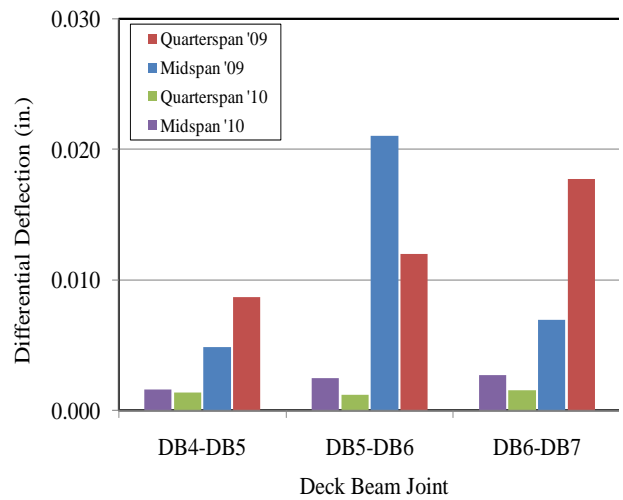

f. LC6

Figure 4.5. 2009 and 2010 Differential deflections

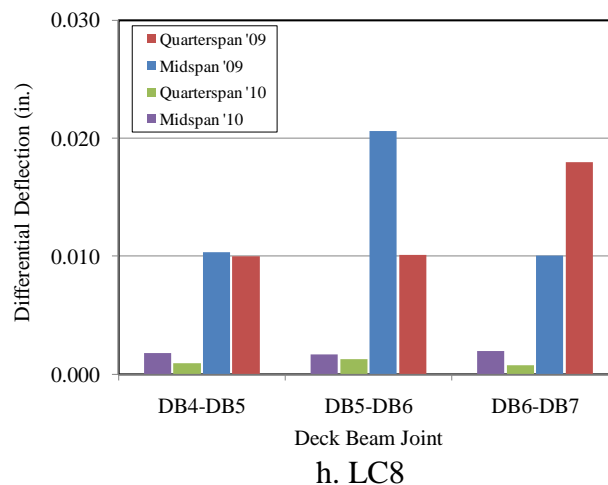
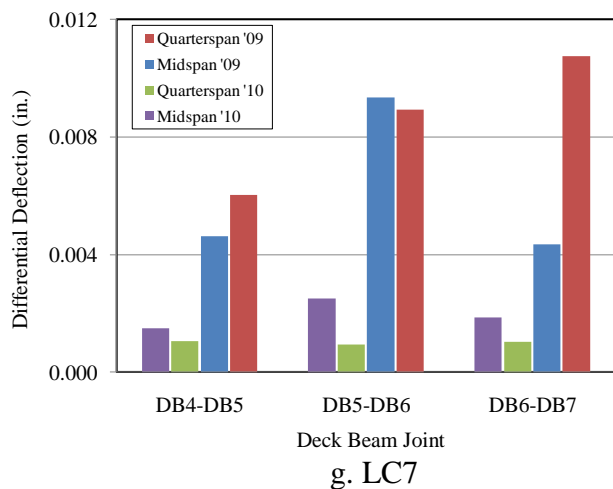

Figure 4.5. Continued

In 2009 global bridge displacements were measured on each side of the joints between DB4 and 5, DB5 and 6, and DB6 and 7; these values were then used to determine the differential values.

In 2010, the transducer (shown in Figure 3.2), which measures differential displacements between adjacent units, was used to determine differential displacements directly. When reviewing the data in Figure 4.3, note that two different vertical scales were used.

Two things are readily apparent. In 2009, for all load cases, although small, there was more differential movement at midspan at the joint between DB5 and 6 than at the other two joints investigated. And, differential movement between all three joints is significantly less in 2010 than it was in 2009.

The only explanation for this improvement that the researchers can think of is a difference in temperature for the two test days, which resulted in more tension (and thus more friction between the various deck beams) in the cross tie rods.

To confirm the results from the transducers used in 2010, two different laboratory tests were used to determine the accuracy and repeatability of results obtained with the transducers. Results obtained in the laboratory using the transducers were determined to be reproducible with satisfactory accuracy.

In 2009, at quarterspan, the maximum differential movement measured was 0.018 in., which occurred for both LC6 and LC8 at DB6-DB7; at midspan, the maximum differential movement measured was 0.021 in., which also occurred during the same two load cases (LC6 and LC8) at DB5-DB6.

In 2010, as noted previously, the differential movements were significantly less (approximately 1/10 as much) for all load cases and all joints. At the quarterspan, the maximum differential

movement measured was 0.0015 in. for LC6 at DB6-DB7 (same location and one of the same load cases as in 2009). At the midspan joint DB5-DB6, the maximum differential movement measured (0.0025 in.) for both loaded cases, LC6 and LC7.

The fact that the differential movements were small in 2009 and significantly smaller in 2010, leads the researchers to believe the grouted shear keys (between adjacent box beams) and the two transverse hand-tightened post tensioning bars are more than adequate for transverse load transfer.

However, these two tests do not allow for any conclusions to be made as to this behavior to continue throughout the life of the bridge.

4.1.2. Bridge Strains

BDI strain transducers (24 used in 2009 and 11 used in 2010) were installed on the bottom side of the box beams to obtain strain data for each of the load cases. The maximum midspan strains measured for each load case in 2009 and 2010 are shown in Tables 4.4 and 4.5, respectively.

Table 4.4. 2009 Maximum midspan girder strains

Strain	Load Case							
	LC1	LC2	LC3	LC4	LC5	LC6	LC7	LC8
Magnitude ($\mu\epsilon$)	58	47	41	42	54	86	77	74
Location	DB7	DB6	DB3	DB3	DB1	DB3	DB6	DB3
Gage	(B12)	(B9)	(B3)	(B3)	(B1)	(B3)	(B9)	(B3)

Table 4.5. 2010 Maximum midspan girder strains

Strain	Load Case							
	LC1	LC2	LC3	LC4	LC5	LC6	LC7	LC8
Magnitude ($\mu\epsilon$)	55	50	41	43	57	71	80	81
Location	DB6	DB6	DB5	DB4	DB1	DB1	DB3	DB1
Gage	(B9)	(B9)	(B6)	(B4)	(B1)	(B1)	(B3)	(B1)

The maximum strain measured during the 2009 load tests occurred during LC6 in DB3 (Gage B3) and was 86 $\mu\epsilon$. In 2010, the maximum strain (81 $\mu\epsilon$) measured during LC8 in DB1 (Gage B1). A review of these two tables reveals minimal differences in the maximum strains measured; however, except, for a couple load cases, the maximum strains that occurred did so in different box beams. When comparing strains from 2009 and 2010, the researchers also kept in mind the slight difference in truck weights from year to year.

Distributions of midspan box beam strains measured in the seven box beams for each of the eight load cases completed in 2009 and 2010 are shown in Figure 4.6.

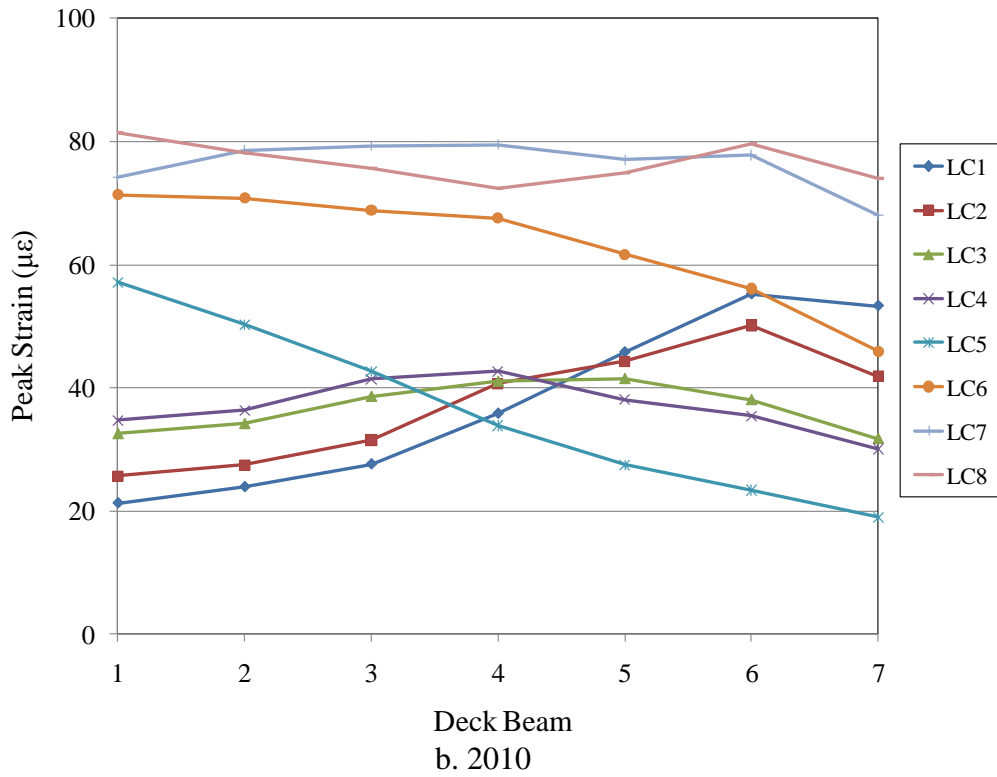
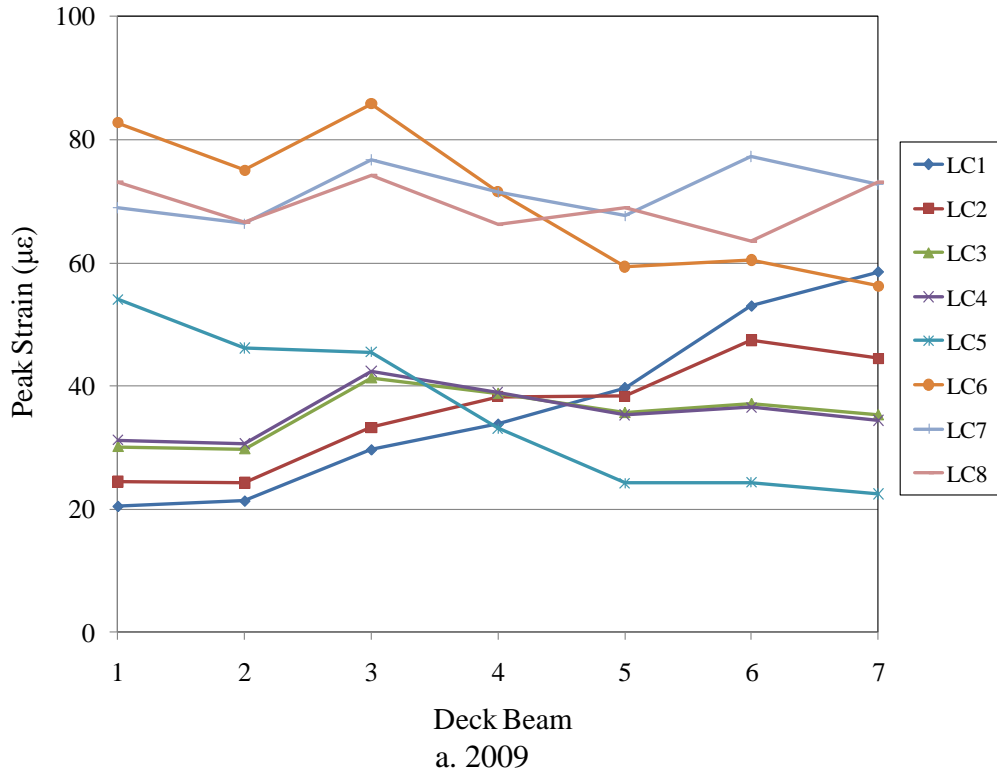

Figure 4.6. Midspan strains for various load cases

Considering the slight difference in the truck weights between 2009 and 2010 (Figure 3.4) and the variation in the transverse distribution of the gravel in the trucks used in the 16 different tests (eight in 2009 and eight in 2010), there is very good agreement in the magnitudes of strains measured each year, as well as their distribution in the seven box beams.

A review of the strains measured in 2009 indicates that, more than likely, there was a problem with the BDI or its installation on DB3 and DB5. Maximum values observed in this figure were tabulated and shown previously in Tables 4.4 and 4.5 (2009 and 2010 test data, respectively).

Distribution of box beam strains for a representative load case, LC1, as the test vehicle crosses the bridge are presented in Figures 4.7 and 4.8 for the 2009 and 2010 tests, respectively. In 2009, three sections were instrumented: midspan (Figure 4.7a), quarterspan (Figure 4.7b), and near the bridge end (1 ft 6 in. from the face of the abutment in Figure 4.7c).

In 2010, two sections were instrumented: midspan (Figure 4.8a) and near the end (as in 2009, 1 ft 6 in. from the face of the abutment in Figure 4.8b). The end span sections were instrumented to determine if there was significant end restraint due to construction details.

A review of the strains in the box beams instrumented (DB4, DB5, DB6, and DB7) – small tensile strains – indicated minimal end restraint. It is interesting to note that the magnitude of strains measured each year were essentially the same although maximum values in 2010 occurred when the truck's front axle was approximately 10 ft farther from the end of the bridge.

Similar results were seen at midspan (Figures 4.7a and 4.8a), with essentially the same magnitude of strain occurring in 2009 and 2010; however, the maximum strain in 2010 occurred when the truck was approximately 10 ft farther from the end of the bridge. The only possible explanation the researchers have for this behavior is there may have been an error in determining the location of the truck on the bridge in 2009 or 2010.

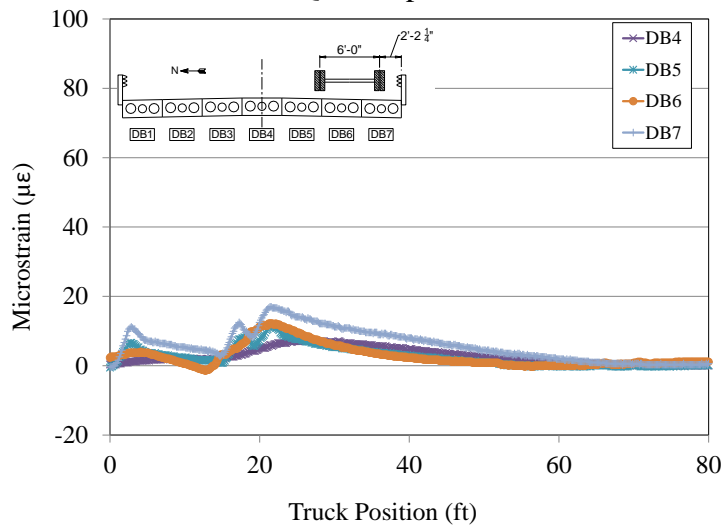
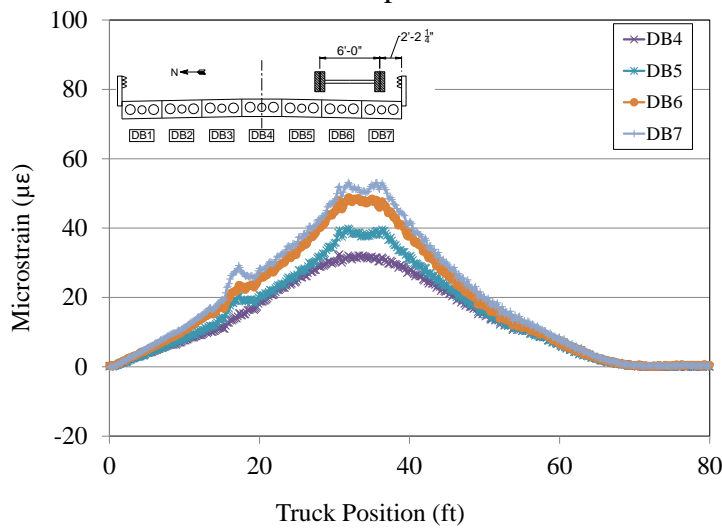
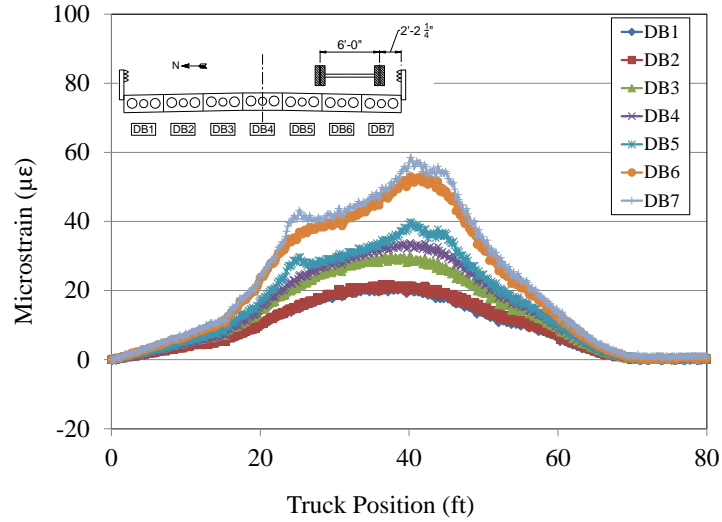
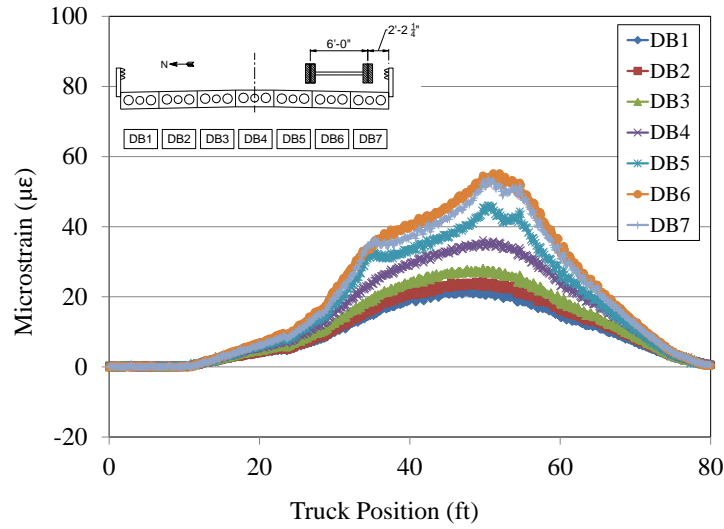
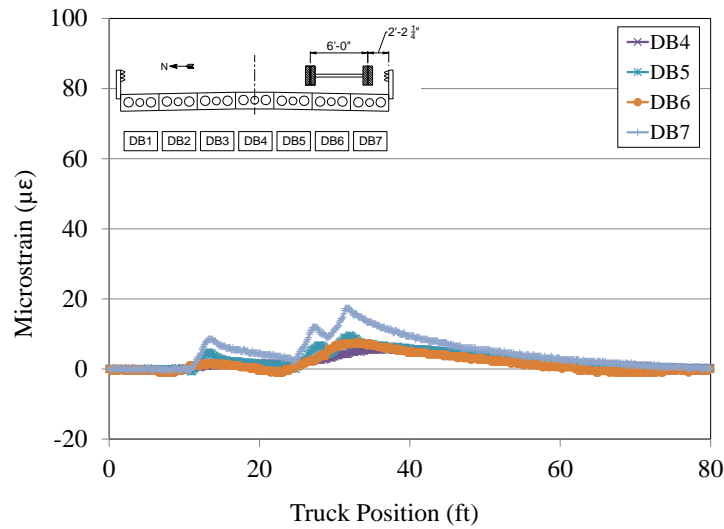

Figure 4.7. 2009 Experimental strains for LC1



a. Midspan strain



b. Strain 1 ft 6 in. from face of abutment

Figure 4.8. 2010 Experimental strains for LC1

4.1.3. Bridge Load Fraction and Load Distribution

Load fractions were calculated for each load case based on the assumption that the box beams have equal stiffness; effect of guardrails on exterior box beams (DB1 and DB7) stiffnesses was not taken into account. Based on this assumption, box beams can be calculated using the following equation:

$$LF_i = \frac{\epsilon_i}{\sum_{i=1}^n \epsilon_i} \tag{4-1}$$

where LF_i = load fraction for the i th box beam, ϵ_i = strain measured in the i^{th} box beam, $\Sigma\epsilon_i$ = sum of all box beam strains for a particular load case, and n = number box beams in the bridge (7 in this particular bridge).

The load fractions determined for the 2009 and 2010 tests are shown in Figure 4.9.

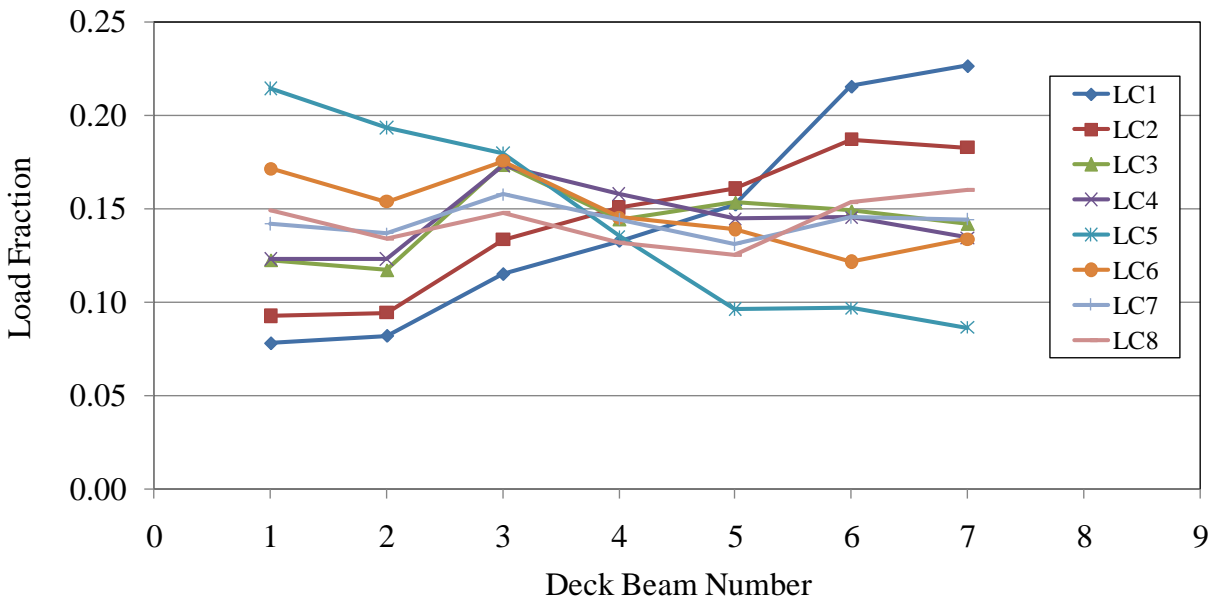

a. 2009 Midspan load fraction for eight load cases

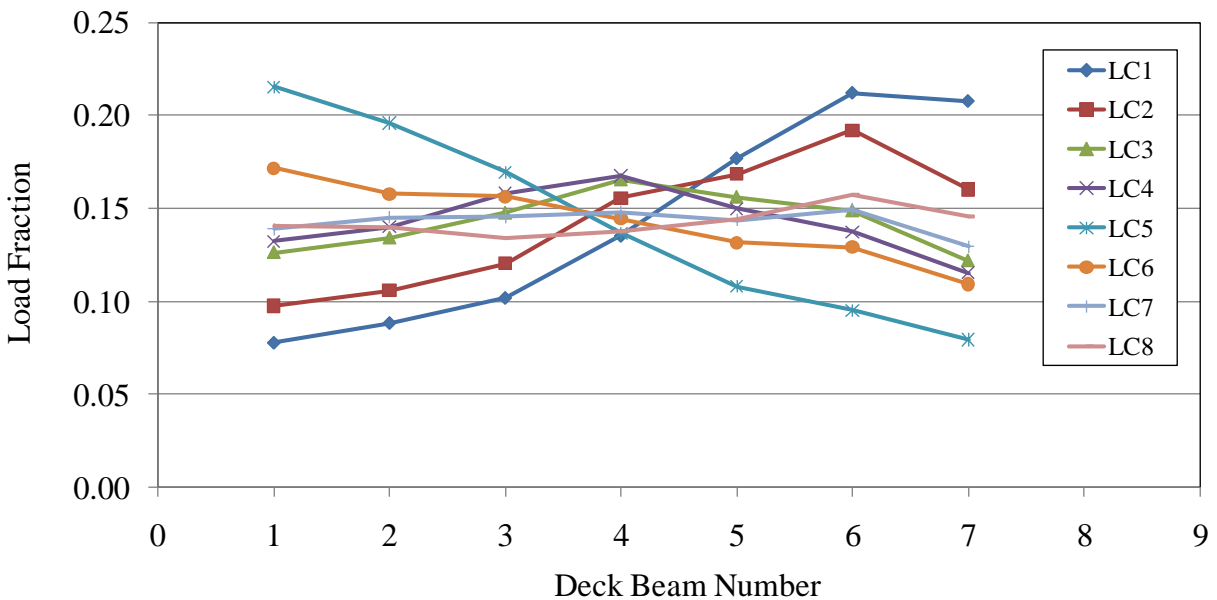

b. 2010 Midspan load fraction for eight load cases

Figure 4.9. Experimentally-determined load fractions

The largest load fraction (0.23) in 2009 occurred in DB7 while the smallest load fraction (0.07) occurred in DB1. Both of these values occurred during LC1.

In the 2010 load tests, the maximum load fraction (0.22) occurred in DB1 during LC5 and the smallest load fraction (0.075) also occurred in DB1, but during LC1.

The values of load fractions determined in 2009 and 2010 given potential experimental error are essentially the same. As expected, the load fraction was largest in the deck beams directly below the truck tires and decreased as the transverse distance from the deck beam to the loaded truck increased. When the truck was located at the transverse center of the bridge, LC3, as expected, the load was distributed approximately equal to all deck beams.

Representative load fraction determined for one truck on the bridge for LC1, LC2, and LC5 are compared to code values, and the values used by the Iowa DOT in their design calculations in Figure 4.10. As shown, the values determined using experimental data are significantly smaller than the code and design calculation values.

As shown in Figure 4.10, there is excellent agreement between the distribution results obtained in 2009 and 2010 for the three load cases in the figure. Although the results for the other load cases have not been included in this report, there was excellent agreement between values from the two years.

To obtain an approximation of lane load distribution, data from two trucks on the bridge were used. In 2009, this involved LC6 and LC7. Data for LC8 (shown in Figure 3.3) was obtained by adding the results from LC1 and LC5. In 2010, only LC7 was actually completed in the field. Results for LC6 and LC8 were obtained by adding the results for having one truck on the bridge ($LC6 = LC3 + LC5$; $LC8 = LC1 + LC5$). Load fraction for these three combination load cases are shown in Figure 4.11.

In this figure, as was the case in Figure 4.10, the experimental values obtained in 2009 and 2010, which are essentially the same, are compared to the design values used by the Iowa DOT, code distribution factors from the 1998 AASHTO LRFD, and code distribution factors from the 1996 AASHTO standard specifications.

A review of the three graphs in this figure (i.e., comparing the experimental values, AASHTO values, and the Iowa DOT values) show the bridge's performance is conservative.

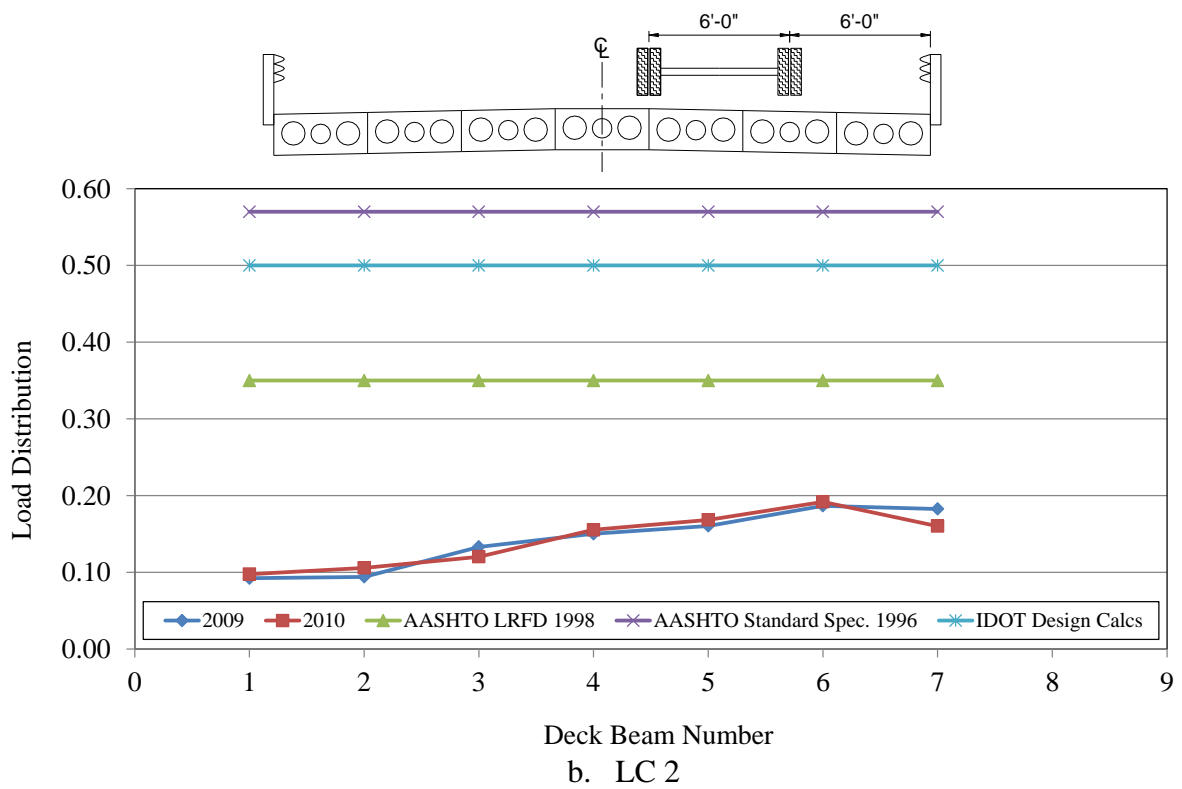
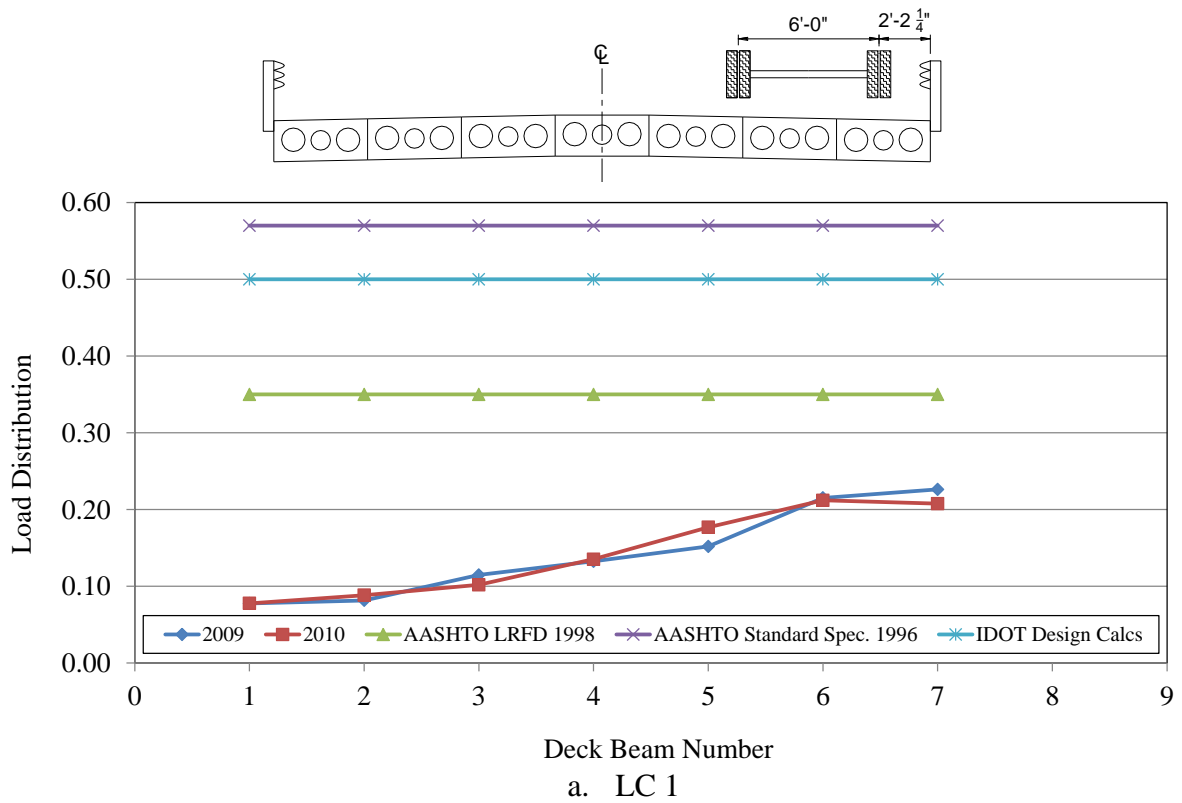

Figure 4.10. Experimental and codified load distributions for one truck on bridge

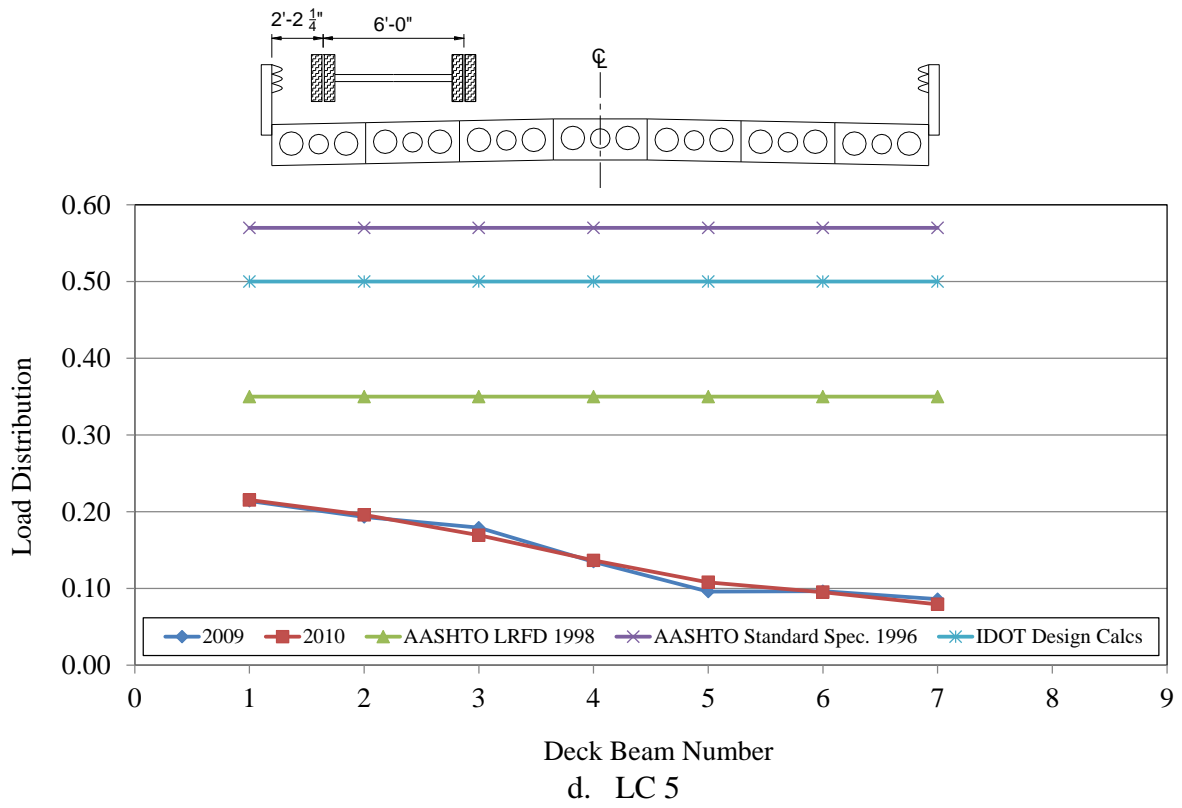
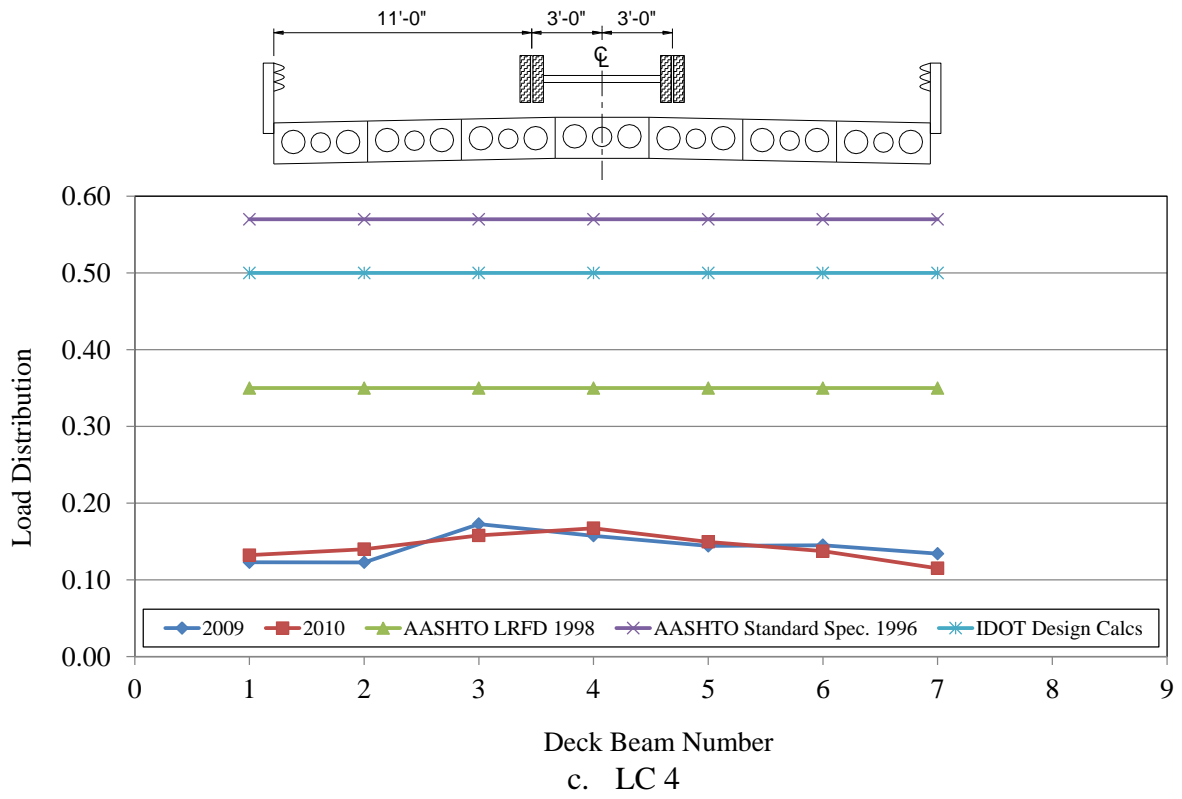

Figure 4.10. Continued

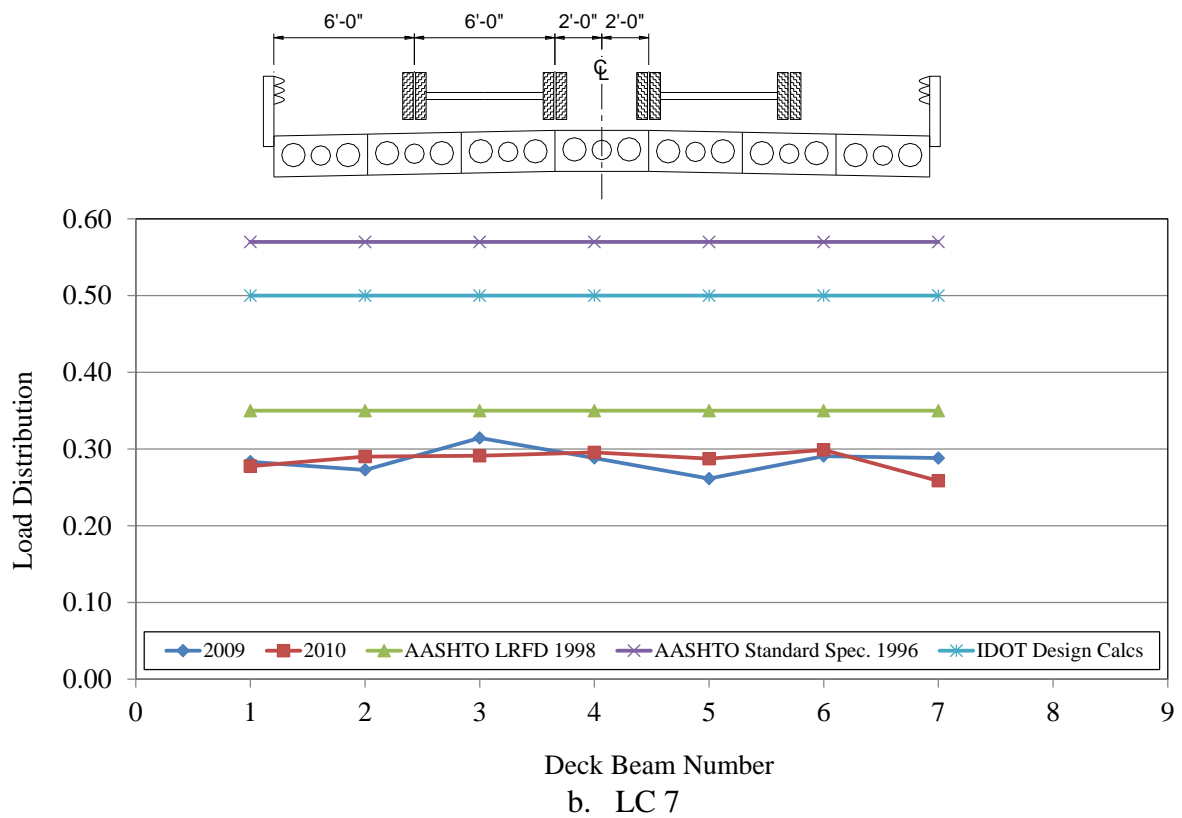
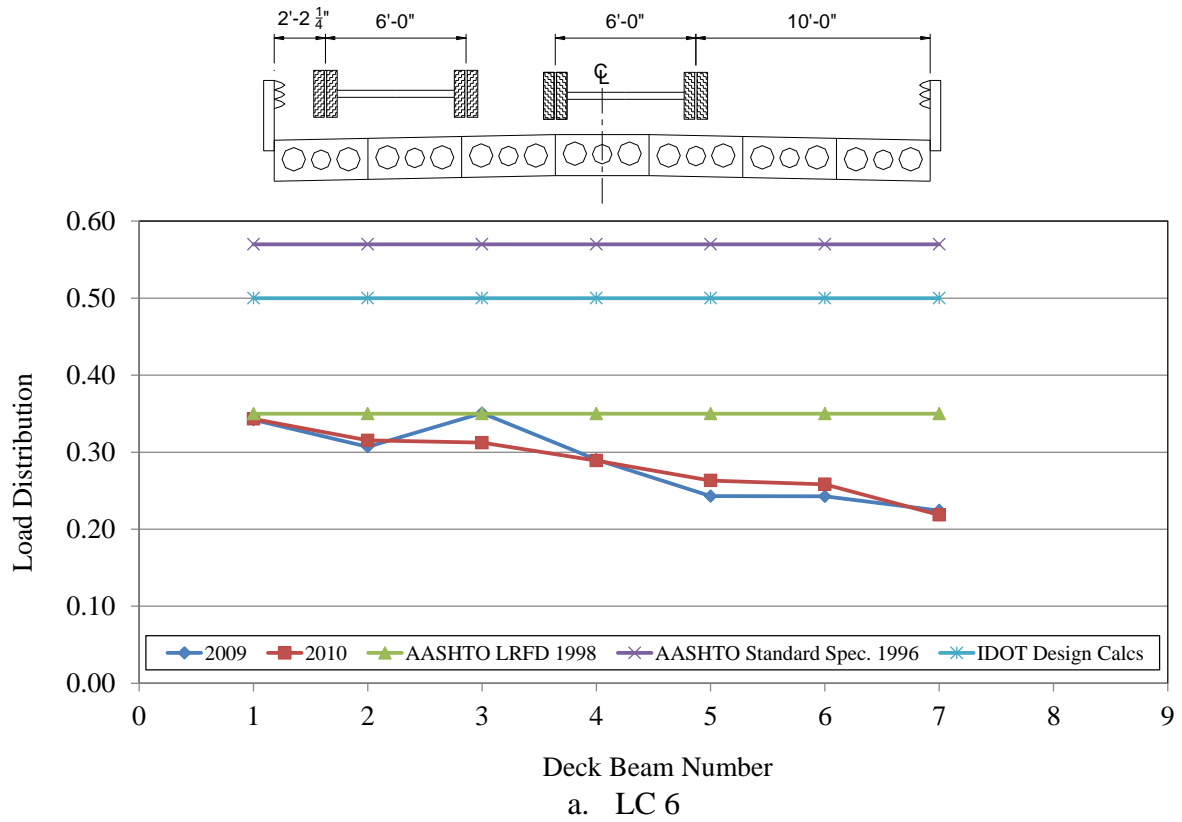

Figure 4.11. Experimental and codified load distribution for lane loading

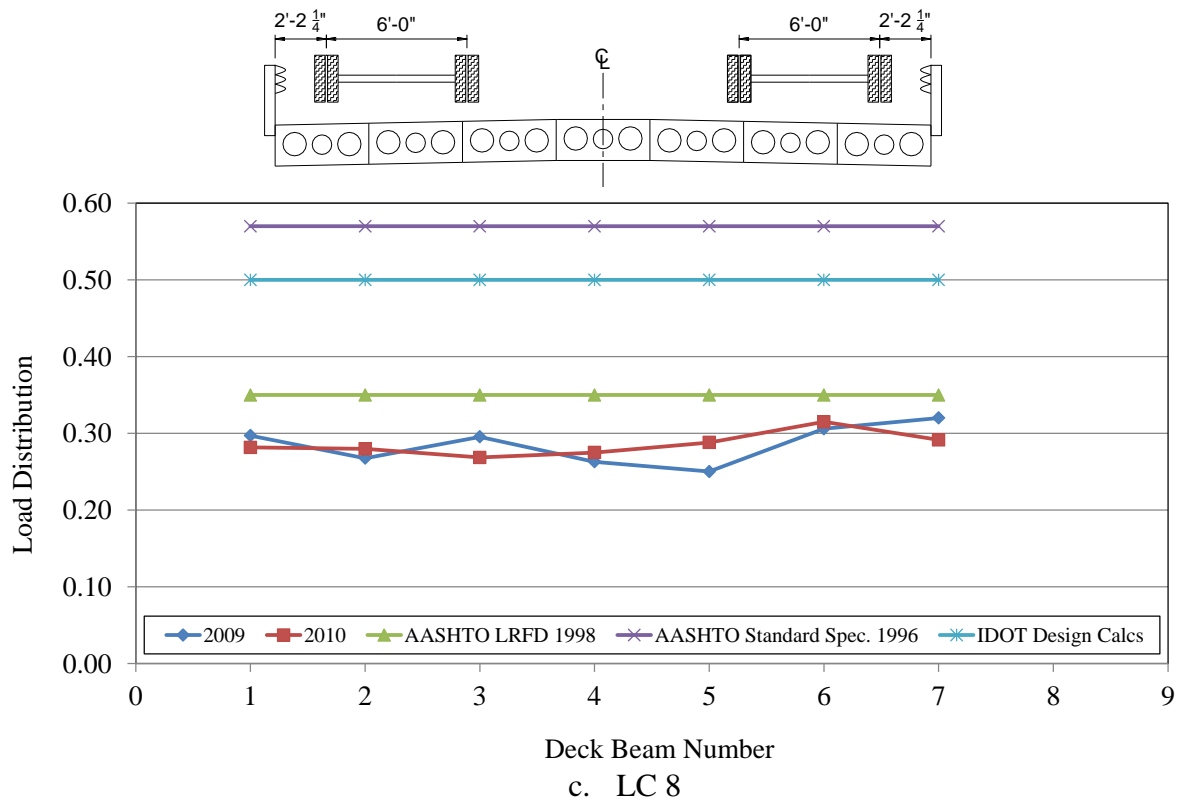

Figure 4.11. Continued

5. SUMMARY, CONCLUSIONS, AND RECOMMENDATIONS

The objective of this project was to evaluate the overall design, construction, and field performance of this type of precast bridge. To achieve these objectives, the various phases of fabrication and construction were observed and two separate field tests were completed.

Pre-assembly of the various precast elements completed in the casting yard was definitely worth the effort. By pre-assembling, problems can be identified early and resolved before the precast elements are delivered to the bridge site, eliminating costly delays in the field.

Prior to shipment to the field, the overall dimensions of all precast elements should be checked to see that they conform to the plans. If that had been done on this project, the delay caused by DB3 being too large on one edge could have been eliminated.

Non-shrink, non-metallic grout was used to fill the joints between adjacent deck beams, pockets required for tightening the transverse tie assembly, and other voids in the bridge assembly. Unfortunately, the contractor used water from the creek for mixing the grout. Depending on the impurities in the water, it could have a deteriorating effect on the grout strength and its long-term performance. In future applications, only potable water should be used in mixing the grout.

Based on observations and field testing, the following conclusions and recommendations can be made:

- This bridge was completed in 18 days (days from closure to reopening). Construction of the bridge (including removal of the existing bridge at the site) took only four working days. The remainder of the time was spent constructing the roadway approaches to the bridge. Due to the low volume of traffic on this road, it wasn't necessary to actually accelerate completion of the bridge and thus the approach fill was completed using county personnel. If the bridge had been on a high volume of traffic road and thus desired to be open as soon as possible (obviously a function of the site), it is estimated that the fill could have been completed in three days. Total road/bridge closure would have been only eight days then.
- The maximum bridge deflection measuring during testing was 0.259 in. Normalizing this value for the different between test truck weights and the weight of design trucks, this value becomes 0.479 in., which is significantly less than code requirements.
- Very small differential movement occurred between adjacent box beams. In 2009, the maximum value measured was 0.021 in. while in 2010 it was significantly less (.0027 in.). The hand-tightened transverse tie rods and grout-filled joints provide good lateral load transfer between adjacent units.
- The maximum box beam strains measured at midspan in 2009 and 2010 were 86 $\mu\epsilon$ and 81 $\mu\epsilon$, respectively. At 28 days, the box beam concrete strength was 7,710 psi (which means the approximate modulus of elasticity of the concrete was 4.55

$\times 10^6$ psi). Assuming this value for E_c mean, the maximum stresses measured in 2009 and 2010 are very small: 390 psi and 370 psi.

- Construction details used in the bridge resulted in minimal end-restraint. Thus, future bridges using these details should be designed as simply-supported, as was done for this bridge.
- The use for the 0.5 load distribution fraction is conservative and thus is recommended for use in the design of other box beam bridges.

REFERENCES

- AASHTO. 1996. *Stand Specifications for Highway Bridges*. Washington, DC: American Association of State Highway and Transportation Officials.
- AASHTO. 2002. *Stand Specifications for Highway Bridges*. Washington, DC: American Association of State Highway and Transportation Officials.
- AASHTO LRFD. 2007. *LRFD Bridge Design Specifications*. Washington, DC: American Association of State Highway and Transportation Officials.
- Hawkins, N. M., and J. B. Fuentes. 2002. *Test to Failure of a 54 ft. Deteriorated Pretensioned Precast Concrete Deck Beam*. Illinois Cooperative Highway and Transportation Series No. 281. University of Illinois: Urbana-Champaign.
- Hawkins, N. M., and J. B. Fuentes. 2003. *Structural Condition Assessment and Service Load Performance of Deteriorated Pretensioned Deck Beam Bridges*. Illinois Cooperative Highway and Transportation Series No. 285. University of Illinois: Urbana-Champaign.
- Klaiber, F. W., T. J. Wipf, and S. Hockerman. 2009. *Precast Concrete Elements for Accelerated Bridge Construction: Laboratory Testing of Precast Substructure Components, Boone County Bridge*. Final Report TR-561, Volume 1-1, Iowa Department of Transportation, 200 pp.
- Phares, B. M., T. J. Wipf, J. Bigelow, R. Bowers, and F. W. Klaiber. 2009. *Precast Concrete Elements for Accelerated Bridge Construction: Evaluation of a Precast Concrete Bridge, Madison County Bridge*. Final Report TR-561, Volume 2, Iowa Department of Transportation, January, 96 pp.
- Wipf, T. J., F. W. Klaiber, B. Phares, and M. Becker. 2009. *Precast Concrete Elements for Accelerated Bridge Construction: Field Testing of Precast Concrete Bridge, Boone County Bridge*. Final Report TR-561, Volume 1-3, Iowa Department of Transportation, January, 41 pp.

APPENDIX A. BUENA VISTA BOX GIRDER BRIDGE PLANS

CONVENTIONAL SIGNS

- DIVIDED HIGHWAY
- PAVED ROAD
- BITUMINOUS ROAD
- GRAVEL ROAD
- EARTH ROAD
- INTERSTATE HIGHWAY
- UNITED STATES HIGHWAY
- COUNTY HIGHWAY
- RAILROAD
- PIPELINE
- AIRPORT
- HYDROLOGY
- BRIDGE
- STATE BOUNDARY
- COUNTY BOUNDARY
- CORPORATE LIMIT LINE
- TOWNSHIP LINE
- SECTION LINE

LOWA Department of Transportation
Highway Division

PLANS OF PROPOSED IMPROVEMENTS ON THE
SECONDARY ROAD SYSTEM
BUENA VISTA COUNTY
BRIDGE REPLACEMENT - OTHER
640th STREET
OVER BRANCH RACCOON RIVER

THE IOWA DEPARTMENT OF TRANSPORTATION STANDARD SPECIFICATIONS FOR HIGHWAY AND BRIDGE CONSTRUCTION, SERIES 2001, PLUS APPLICABLE GENERAL, SUPPLEMENTAL, SPECIAL SPECIFICATIONS, DEVELOPMENTAL SPECIFICATIONS, SUPPLEMENTAL SPECIFICATIONS, AND SPECIAL PROVISIONS SHALL APPLY TO CONSTRUCTION WORK ON THIS PROJECT.

VALUE ENGINEERING SAVES. REFER TO THE GENERAL NOTES IN THESE PLANS.

INDEX OF SHEETS

NO.	TITLE SHEET	DESCRIPTION
1	ESTIMATE SHEET - DESIGN 109	ESTIMATE SHEET - DESIGN 109
2-13	STRUCTURE RAIL DETAILS	STRUCTURE RAIL DETAILS
11	SLAB BARRIER RAIL DETAILS	SLAB BARRIER RAIL DETAILS
12	ROAD PROFILE	ROAD PROFILE
13		

INDEX OF SEALS

SHEET NO.	NAME	TYPE
1	Stuart S. Nielsen	STRUCTURAL
12	John L. Tribb	ROADWAY

STANDARD ROAD PLANS
STANDARD ROAD PLANS ARE LISTED ON SHEET _____

DESIGN DATA RURAL
2003 AADT _____ 45. V.P.D.

REVISIONS

NO.	DATE	DESCRIPTION

STRUCTURAL DESIGN

I hereby certify that this engineering document was prepared by me or under my direct personal supervision and that I am a duly Licensed Professional Engineer under the laws of the State of Iowa.

Signature: Stuart S. Nielsen Date: _____
 Printed Name: Stuart S. Nielsen
 My license renewal date is December 31, 2010.

Pages or sheets covered by this seal: SHEETS 1 THRU 11 OF 13.

LOWA ONE CALL
1-800-232-6369
CALL BEFORE YOU DIG

ALL WORKING DRAWINGS INCLUDING ALL FIELDWORK DRAWINGS WILL BE CHECKED BY:
IOWA DOT OFFICE OF BRIDGES AND STRUCTURES
800 LINCOLN WAY
AMES, IA 50010

LOCATION MAP

INDEX OF SEALS

SHEET NO.	NAME	TYPE
1	Stuart S. Nielsen	STRUCTURAL
12	John L. Tribb	ROADWAY

STRUCTURAL DESIGN

I hereby certify that this engineering document was prepared by me or under my direct personal supervision and that I am a duly Licensed Professional Engineer under the laws of the State of Iowa.

Signature: Stuart S. Nielsen Date: _____
 Printed Name: Stuart S. Nielsen
 My license renewal date is December 31, 2010.

Pages or sheets covered by this seal: SHEETS 1 THRU 11 OF 13.

STANDARD ROAD PLANS
STANDARD ROAD PLANS ARE LISTED ON SHEET _____

DESIGN DATA RURAL
2003 AADT _____ 45. V.P.D.

REVISIONS

NO.	DATE	DESCRIPTION

STRUCTURAL DESIGN

I hereby certify that this engineering document was prepared by me or under my direct personal supervision and that I am a duly Licensed Professional Engineer under the laws of the State of Iowa.

Signature: Stuart S. Nielsen Date: _____
 Printed Name: Stuart S. Nielsen
 My license renewal date is December 31, 2010.

Pages or sheets covered by this seal: SHEETS 1 THRU 11 OF 13.

ITEM NO.	ITEM CODE	ITEM DESCRIPTION	UNIT	TOTAL	AS BUILT QUANTITY
1	2102-210010	EXCAVATION, CL, 10' DEEP X 60' WIDE	CF	10	
2	2102-210020	EXCAVATION, CL, 20' DEEP	CF	20	
3	2402-212000	EXCAVATION, CL, 20'	CF	600	
4	2501-400100	PILE, HP, D637	LF	147'-0"	
5	2505-400200	INSTALLATION OF GUARDRAIL	LF	4	
6	2505-400280	GUARDRAIL, SPECIAL ANCHOR, RE-2B, TYPE 'C'	EACH	160	
7	2507-325000	ENGINEER FABRIC	SY	200	
8	2507-480000	REINFORCEMENT, CLASS E	TON	4	
9	2518-491000	SAFETY CLOSURE	EACH	4	
10	2533-480000	REINFORCING BAR	LS	1	
11	2533-480000	WIRE MESH	LS	1	
12	2599-999000	PRECAST ABUTMENT FOOTING	EACH	2	
13	2599-999000	PRECAST ABUTMENT	EACH	7	
14	2599-999000	PRECAST BACKWALL - ABUTMENT	EACH	4	

GENERAL NOTES:

THIS DESIGN IS FOR THE REPLACEMENT OF THE EXISTING 25' X 17'-1" SINGLE SPAN CONCRETE BRIDGE CONSTRUCTED IN 1936. NO KNOWN COPIES OF THE ORIGINAL PLAN EXIST. THE EXISTING BRIDGE SUPERSTRUCTURE CONSISTS OF A CONCRETE DECK WITH PRECAST ADJUSTMENT FOOTINGS AND PRECAST PRESHRESSED DECK BOX BEAMS. THE BRIDGE HAS 25' X 17'-1" SPAN ON PILES. THESE INNOVATIVE BRIDGE RESEARCH AND CONSTRUCTION (IBRC) ACCELERATED BRIDGE CONSTRUCTION (ABC) WITH PRECAST ADJUSTMENT FOOTINGS AND PRECAST PRESHRESSED DECK BOX BEAMS. THE UTM, SUN BID FOR REMOVAL OF EXISTING BRIDGE SHALL INCLUDE THE COST OF THE EXISTING BRIDGE AND THE COST OF THE EXISTING BRIDGE SHALL BECOME THE PROPERTY OF THE CONTRACTOR.

REMARKS SHALL BE ACCORDANCE WITH SECTION 2401 OF THE STANDARD SPECIFICATIONS EXCEPT THAT THE EXISTING BRIDGE SHALL BECOME THE PROPERTY OF THE CONTRACTOR.

FAINT LINES ON PLANS INDICATE THE EXISTING STRUCTURE. UTILITY COMPANIES WHOSE FACILITIES ARE SHOWN ON THE PLANS OR WHOSE TO BE WITHIN THE CONSTRUCTION LIMITS SHALL BE NOTIFIED BY THE BRIDGE CONTRACTOR OF THE STARTING DATE.

THIS BRIDGE IS DESIGNED FOR HL-93 LOADING, PLUS 50 LBS. PER SQUARE FOOT OF ROADWAY FOR FUTURE OVERLAY.

THE BRIDGE CONTRACTOR IS ENCOURAGED TO TAKE FULL ADVANTAGE OF SPECIFICATION 1105 IS - VALUE ENGINEERING INCENTIVE PROPOSAL. A FANPLET CONFERENCE.

IF NECESSARY TO PREVENT DAMAGE TO THE END OF THE BRIDGE DECK OR BACKWALL FROM CONSTRUCTION EQUIPMENT, AN APPROPRIATE METHOD OF PROTECTION APPROVED BY THE ENGINEER SHALL BE PROVIDED BY THE BRIDGE CONTRACTOR AT NO EXTRA COST TO THE STATE OR COUNTY.

EXCESSIVE BRIDGE CONTRACTOR RESPONSIBILITY TO PROVIDE SITES FOR EXCESSIVE MATERIALS TO BE REMOVED FROM OVERLAY SHALL BE ALLOWED FOR MATERIAL HAULLED TO THESE SITES.

NOTE:
THIS PLAN USES NON-STANDARD PILE HEAD SPIRALS. SEE DETAILS FOR ADDITIONAL INFORMATION.

THESE BRIDGE PLANS LABEL ALL REINFORCING STEEL IN THE ENGLISH NOTATION (L50 IS 1/2" INCH DIAMETER BARS). ENGLISH REINFORCING STEEL RECEIVED IN THE FIELD MAY DISPLAY THE FOLLOWING BAR DESIGNATION. THE "BAR DESIGNATION" IS EQUIVALENT TO THE BAR DIAMETER IN MILLIMETERS.

ENGLISH SIZE	BAR DESIGNATION
3	10
4	13
5	16
6	19
7	22
8	25
9	29
10	32
11	36

SPECIFICATIONS:

DESIGN ASHTO LFD BRIDGE DESIGN SPECIFICATIONS, 4TH EDITION, 2007.
CONSTRUCTION FOR HIGHWAY AND BRIDGE CONSTRUCTION, SERIES 2001, PLUS APPLICABLE GENERAL SUPPLEMENTAL SPECIFICATIONS, AND SPECIAL PROVISIONS, INCLUDING DEVELOPMENTAL SPECIFICATIONS FOR HIGH PERFORMANCE CONCRETE FOR CONSTRUCTION WORK ON THIS PROJECT.

DESIGN STRESSES:

DESIGN STRESSES FOR THE FOLLOWING MATERIALS ARE IN ACCORDANCE WITH THE SPECIFICATIONS FOR HIGHWAY AND BRIDGE CONSTRUCTION, SERIES 2001, REINFORCING STEEL IN ACCORDANCE WITH SECTION 5, GRADE 60. CONCRETE IN ACCORDANCE WITH SECTION 5, $f'_c = 3,500$ PSI. PRECAST ABUTMENT FOOTING CONCRETE IN ACCORDANCE WITH SECTION 5, $f'_c = 5,000$ PSI.

ROADWAY GRADING
NOTE: ALL ROAD GRADING TO BE PERFORMED BY BUENA VISTA COUNTY FORCES.

TRAFFIC CONTROL PLAN
NOTE: THE ROADWAY WILL BE CLOSED TO THRU TRAFFIC.

50'-0" X 28' PRECAST PRETENSIONED BOX BEAM BRIDGE
50'-0" SPAN
STA. 11+58.4
DESIGN FOR 6° SKEW
GENERAL NOTES AND QUANTITIES
APRIL 2009
BUENA VISTA COUNTY
IOWA DEPARTMENT OF TRANSPORTATION - HIGHWAY DIVISION
DESIGN SHEET NO. J. OF 12. FILE NO. 20355. DESIGN NO. 109

ESTIMATE REFERENCE INFORMATION	
ITEM NO.	DESCRIPTION
12	<p>THIS ITEM INCLUDES ALL COSTS FOR FURNISHING AND PLACING THE PRECAST ABUTMENT FOOTING INCLUDING ONE ABUTMENT 8' X 10' OF STRUCTURAL CONCRETE (BRIDGE), 1394 LBS. REINFORCING STEEL, WITH MECHANICAL SPLICES FOR THE BACKWALL, AND 1.5 C.Y. OF 21' CMP, AND 1.5 C.Y. OF STRUCTURAL CONCRETE (MISC.) TO BACKFILL THE PILE VOIDS.</p> <p>INCLUDES COST OF TEMPORARILY BRACING THE ABUTMENT FOOTING UNTIL THE CONCRETE BACKFILL IN THE PILE VOIDS HAS OBTAINED THE REQUIRED STRENGTH.</p> <p>THE METHOD OF MEASUREMENT AND BASIS OF PAYMENT WILL BE FOR EACH PRECAST ABUTMENT FOOTING (2 REQUIRED) FURNISHED AND PLACED.</p> <p>INCLUDES ALL PREFORMED EXPANSION JOINT FILLER REQUIRED.</p> <p>INCLUDES ANY FLOWABLE MORTAR PLACED UNDER THE PRECAST ABUTMENT TO FILL VOIDS OR TO HELP SUPPORT THE ABUTMENT DURING PLACEMENT.</p>
13	<p>INCLUDES ALL COSTS ASSOCIATED WITH FURNISHING AND PLACING THE PREFORMED PRECAST BACK WALLS INCLUDING FOUR BACKWALLS 5.2 C.Y. OF STRUCTURAL CONCRETE (BRIDGE), 1181 LBS. REINFORCING STEEL, WITH MECHANICAL SPLICES FOR THE ROOFS, WASHERS, NUTS, ETC. NEEDED FOR THE TRANSVERSE ASSEMBLY OF THE PANELS.</p> <p>INCLUDES 1.5 C.Y. OF GROUT FOR SHEAR KEYS BETWEEN PANELS.</p> <p>GRADATION OF COURSE AGGREGATES FOR PRESTRESSED CONCRETE BRIDGE UNITS SHALL MEET THE REQUIREMENTS OF SECTION 415 CLASS 3 DURABILITY. GRADATION OF THE COURSE AGGREGATE SHALL MEET THE REQUIREMENTS OF SECTION 2407.02A.</p>
14	<p>THIS ITEM INCLUDES ALL COSTS FOR FURNISHING AND PLACING THE PRECAST ABUTMENT BACKWALLS INCLUDING FOUR BACKWALLS 5.2 C.Y. OF STRUCTURAL CONCRETE (BRIDGE), 1181 LBS. REINFORCING STEEL, INCLUDES EPOXY GROUT AND SLAB DOWELS FOR THE BACKWALL.</p> <p>THE METHOD OF MEASUREMENT AND BASIS OF PAYMENT WILL BE FOR EACH PRECAST ABUTMENT BACKWALL FURNISHED AND PLACED.</p>

DESIGN FOR 0° SKEW
50'-0" X 28' PRECAST PRETENSIONED BOX BEAM BRIDGE
 50'-0" SPAN
 APRIL 2009
 STA. 11+26.4
ITEM REFERENCE
BUENA VISTA COUNTY
 IOWA DEPARTMENT OF TRANSPORTATION - HIGHWAY DIVISION
 DESIGN SHEET NO. 2 OF 12 FILE NO. 20355 DESIGN NO. 109
 PROJECT NUMBER: IBRC-C011861-8E-11 SHEET NUMBER: 3

BENCHMARK SPIKE ON NORTH SIDE OF PP ELEV. = 100.00



VP1 STA. = 64.25
 VPI ELEV. = 78
 VC = 600

**PROPOSED PROFILE
 GRADE 640TH STREET**

95	WEST ABUTMENT ELEV. = 89.2	TOP OF BERM ELEV. = 90.3	EAST ABUTMENT ELEV. = 90.3	95
90	TOP OF BERM ELEV. = 88.8	TOP OF BERM ELEV. = 89.3	TOP OF BERM ELEV. = 89.8	90
85	BOTTOM P.C. ELEV. = 84.5	BOTTOM P.C. ELEV. = 85.0	BOTTOM P.C. ELEV. = 85.5	85
80	BOTTOM P.C. ELEV. = 84.5	BOTTOM P.C. ELEV. = 85.0	BOTTOM P.C. ELEV. = 85.5	80
75	BOTTOM P.C. ELEV. = 84.5	BOTTOM P.C. ELEV. = 85.0	BOTTOM P.C. ELEV. = 85.5	75
70	BOTTOM P.C. ELEV. = 84.5	BOTTOM P.C. ELEV. = 85.0	BOTTOM P.C. ELEV. = 85.5	70

LONGITUDINAL SECTION ALONG CL ROADWAY

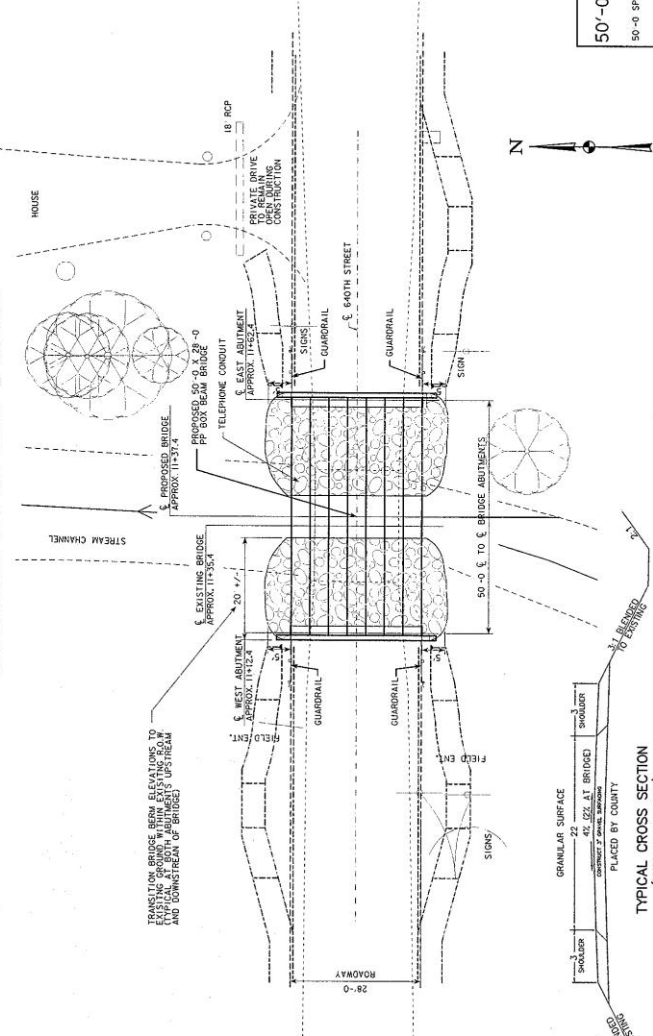

SITUATION PLAN



**TYPICAL CROSS SECTION
 (NEAR BRIDGE)**



HYDRAULIC DATA
 DRAINAGE AREA = 42.8 SQUARE MILES
 Q = 1650 CFS
 STAGE W/BACKWATER = 85.8
 NATURAL STAGE AT BRIDGE = 84.8

ROAD NOTE:
 PLEASE REFER TO ENGINEERING FABRIC
 ACCORDING TO THE IOWA DOT STANDARD
 SPECIFICATIONS.

LOCATION

640TH STREET OVER
 BRANCH RACCOON RIVER
 T-20 N. R-36 W. R-36
 PROVIDENCE TOWNSHIP
 BUENA VISTA COUNTY
 IOWA DOT PROJECT NO. 20255
 FHWA #084510

**50'-0" X 28' PRECAST PRESTRESSED
 BOX BEAM BRIDGE**

DESIGN FOR 0° SKEW
 50'-0" SPAN
 STA. 11+35.4

SITUATION PLAN
 BUENA VISTA COUNTY
 APRIL 2009

IOWA DEPARTMENT OF TRANSPORTATION - HIGHWAY DIVISION
 DESIGN NO. 109
 PROJECT NUMBER 18RC-CO11861-SE-11
 SHEET NUMBER 4

DESIGN TEAM
 07-JAN-2009 10:47

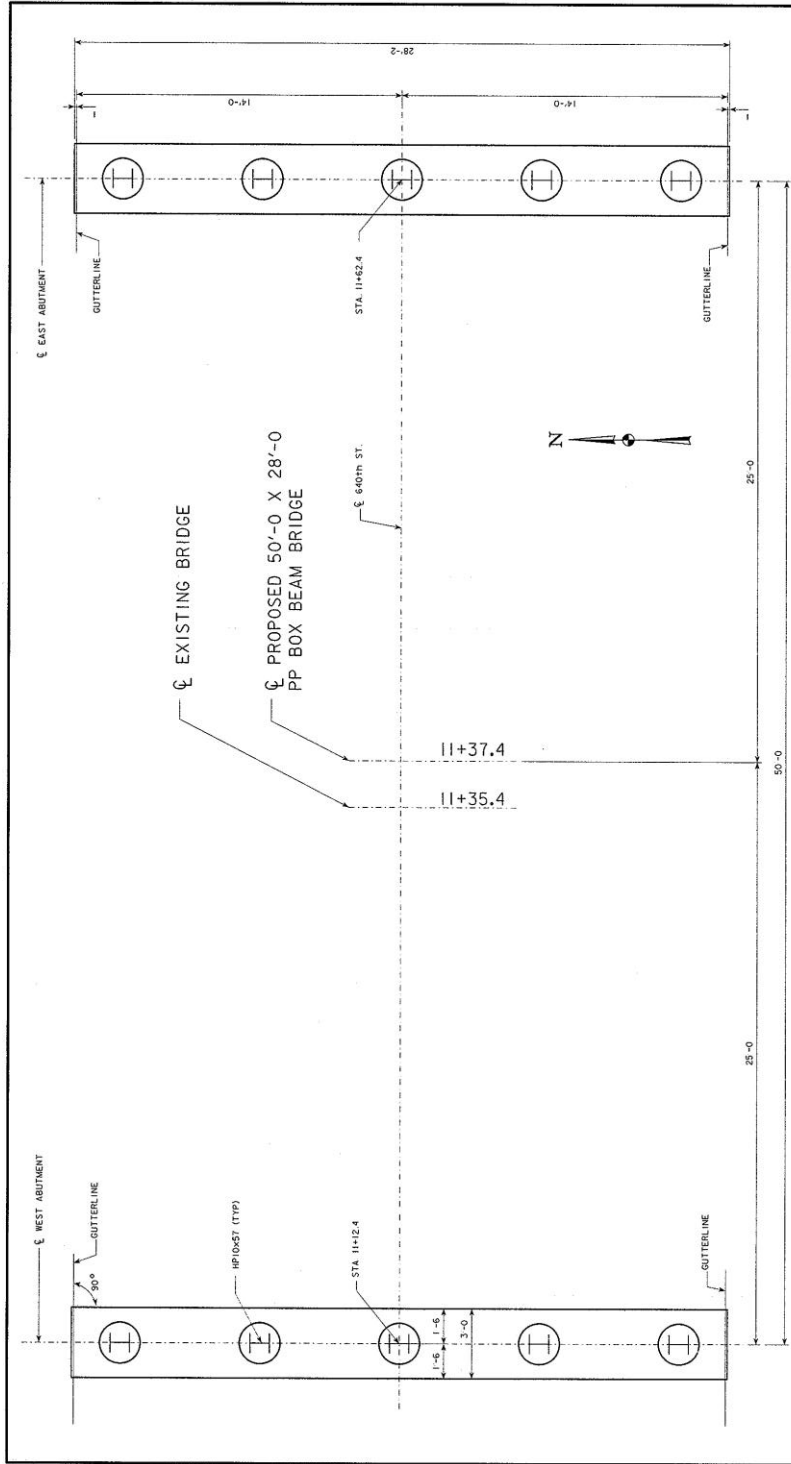

STAKING DIAGRAM

<p>DESIGN FOR 0° SKEW 50'-0 X 28' PRECAST PRETENSIONED BOX BEAM BRIDGE 50'-0 SPAN STA. 11+35.4 IOWA DEPARTMENT OF TRANSPORTATION - HIGHWAY DIVISION DESIGN SHEET NO. 3 OF 12 FILE NO. 20385 DESIGN NO. 103</p>	<p style="text-align: center;">STAKING DIAGRAM</p> <p style="text-align: center;">BUENA VISTA COUNTY APRIL 2009</p> <p style="text-align: center;">PROJECT NUMBER: BRC-CO11861-SE-11 SHEET NUMBER: 5</p>
---	---

DESIGN TEAM: 07-JAN-2009 10:47
 FILE PATH: V:\Projects\Bridges\Structures\Local\System\PrimaryRoutes\Buena Vista\BRC28_Bridge.dwg 610106c04 \v\prjtw2\bridge.dwg

REINFORCING BAR LIST

BAR	LOCATION	NO.	LENGTH	WEIGHT
B1	ABUTMENT FOOTING LONGITUDINAL - FACES	8	27'-8"	511
B2	ABUTMENT FOOTING LONGITUDINAL - TOP	8	4'-0"	34
B3	ABUTMENT ROOPS	56	3'-8"	555
B4	MEDIANICAL SPLICE FOR BACKWALL DOVELS	14	2'-8"	100
B5	PILE SPIRAL	10	13'-0"	55
B6	SPIRAL SPACER L X L X L X 0.70	30	1'-10"	39
B7	REINFORCING STEEL (LBS.)			1384

NOTE: THE BAR RAYS ARE SPACED TO THE BAR MECHANICAL SPACERS IN THE ABUTMENT. MECHANICAL SPACERS SHALL BE IN ACCORDANCE WITH MATERIALS IN 451, APPENDIX E.

BENT BAR DETAILS

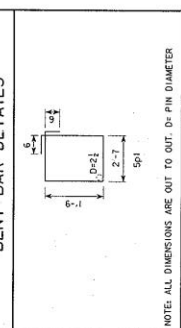

NOTE: ALL DIMENSIONS ARE OUT TO OUT. D= PIN DIAMETER

PRECAST ABUTMENT FOOTING & PILE NOTES:

MINIMUM CLEAR DISTANCE FROM FACE OF CONCRETE TO NEAR REINFORCING BAR IS TO BE 2" UNLESS OTHERWISE NOTED OR SHOWN.

THE DESIGN BEARING FOR THE ABUTMENT PILES IS 47 TONS.

THE PRECAST ABUTMENT FOOTING PICK POINTS OR LIFTING POINTS SHALL BE DESIGNED BY THE PRECAST MANUFACTURER. FLEXURAL EFFECTS SHALL BE CONSIDERED IN THE DESIGN.

PICK POINTS OR LIFTING LOOP LOCATIONS SHALL BE APPROVED BY THE ENGINEER PRIOR TO FABRICATION.

THE METHOD OF SUPPORTING THE PRECAST ABUTMENT FOOTING DURING ERECTION SHALL BE SUBMITTED TO THE ENGINEER ONE WEEK PRIOR TO THE ERECTION FOR REVIEW AND APPROVAL.

THE STRUCTURAL CONCRETE MIXES USED TO FILL THE ABUTMENT PILING ENCASUREMENTS SHALL BE CLASS C-4 CONCRETE WITH A HIGH RANGE WATER REDUCER. THE MAXIMUM SLUMP ACHIEVED WITH WATER SHALL BE 2 INCHES. THE MAXIMUM SLUMP AFTER ADDITION OF THE HRW SHALL BE 4 INCHES. ALLOWABLE SLUMP AFTER ADDITION OF THE HRW SHALL BE 7 INCHES. COARSE AGGREGATE SHALL BE 1 1/2" TOP SIZE.

OTHER MIXES MAY BE CONSIDERED PROVIDED THEY HAVE BEEN REVIEWED AND APPROVED BY THE DISTRICT MATERIALS ENGINEER.

DISTRICT MATERIALS WILL PROVIDE COMPRESSIVE STRENGTH TESTING OF THE CONCRETE USED TO FILL THE ABUTMENT PILING ENCASUREMENTS. THE TESTING SHALL BE CONDUCTED AT THE PRECAST MANUFACTURER'S PLANT. FINISHING SHALL NOT BE INITIATED UNTIL 3500 PSI HAS BEEN ACHIEVED.

FINAL PILE HEAD POSITIONS SHALL NOT DEVIATE FROM THE LOCATION DESIGNATED IN THESE PLANS BY MORE THAN 3" IN ORDER TO ALLOW THE PRECAST FOOTING TO BE INSTALLED.

ESTIMATED QUANTITIES ONE PRECAST ABUTMENT FOOTING

ITEM	UNIT	QUANTITY
STRUCTURAL CONCRETE (ABUTMENT)	CY	8.2
STRUCTURAL CONCRETE (PILE)	CY	1.2
REINFORCING STEEL (LBS.)	LBS	1384
EXCAVATION CLASS 20	LF	33.3
2" COMP	LF	18.0

PILE QUANTITIES BOTH ABUTMENTS

ITEM	UNIT	QUANTITY
E. ABUT. 5' - HPI/POST # 60'-0"		300'-0"
E. ABUT. 5' - HPI/POST # 60'-0"		300'-0"
TOTAL		600'-0"

PRECAST ABUTMENT HEIGHT = 17.2 TONS

DETAIL A

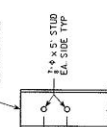

SECTION A-A

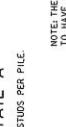

SECTION B-B



NOTE: THE SPIRAL AT THE TOP OF EACH PILE TO HAVE 7 TURNS OF NO. 2 BAR 1/8" DIAMETER, PUNCHED TO HOLD SPIRAL.

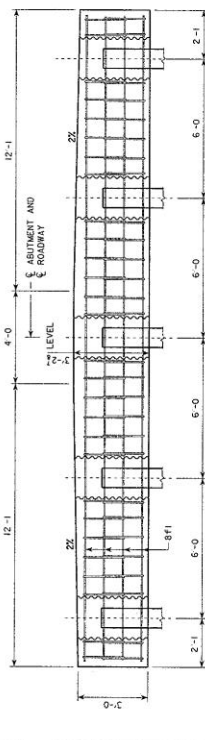

ABUTMENT ELEVATION

(8-2 MECH. SPLICERS SHOWN ON BACKWALL SHEET)

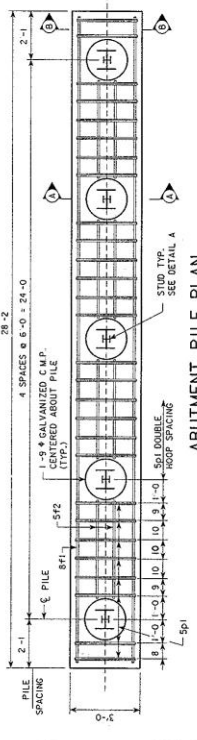

REAR ELEVATION AT ABUTMENT

(BACKWALL NOT SHOWN FOR CLARITY)



TABLE OF ABUTMENT ELEVATIONS

ELEV.	BY	ABUT. E. ABUT.
A	88'-20"	90'-00"
B	88'-56"	90'-06"
BOOTT. OF PILING	84'-13"	85'-83"

DESIGN FOR 6" SKEW 50'-0" SPAN BOX BEAM PRETENSIONED

PRECAST ABUTMENT DETAILS
APRIL 2009
BUENA VISTA COUNTY
IOWA DEPARTMENT OF TRANSPORTATION - HIGHWAY DIVISION
DESIGN SHEET NO. 5 OF 12, FILE NO. 30385, DESIGN NO. 109

DOVEL SETTING NOTE
 THE 601 BARS SHALL BE SET AS DOVELS IN THE PRECAST ABUTMENT. THE DOVELS SHALL BE SET IN ACCORDANCE WITH THE MANUFACTURER'S RECOMMENDATIONS. THE FOLLOWING SYSTEM MAY BE USED AS A GUIDE FOR SETTING DOVELS.

A POLYMER GROUT SYSTEM IN ACCORDANCE WITH STANDARD SPECIFICATIONS.

BACKWALL SETTING NOTE
 SET PRECAST BACKWALLS ON A REZI-WELD OR SIMILAR EPOXY BED. SET PRECAST ABUTMENT ON A REZI-WELD OR SIMILAR EPOXY BED. CONNECT THE PRECAST ELEMENTS.

FOLLOW ALL MANUFACTURER RECOMMENDATIONS FOR INSTALLATION.

CARE SHOULD BE TAKEN TO AVOID SPILLS.

NOTE: THE 601 BARS ARE CLASSIFIED WITH MECHANICAL SPICERS TO THE ABUTMENT. MECHANICAL SPICERS SHALL BE IN ACCORDANCE WITH MATERIALS IN 451, APPENDIX E.

BAR	LOCATION	SHAPE	NO.	LENGTH	WEIGHT
601	BACKWALL VERTICAL STRIRUPS	56	4-8	175	
601	BACKWALL HORIZONTAL	12	16'-5	228	
602	BACKWALL HORIZONTAL	8	16'-0	192	
603	BACKWALL HORIZONTAL	8	16'-7	200	
604	THREADED ONE END BACKWALL DOVELS	28	1'-8	125	
	1" DIAMETER SMOOTH SLAB DOVELS		14	2'-3	132
	REINFORCING STEEL (LBS.)				1181

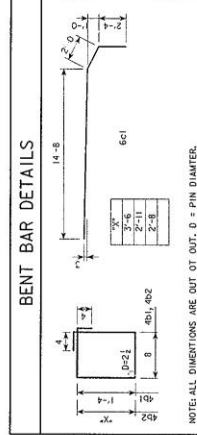

DESIGN FOR 40° SKEW
50'-0" X 28' PRECAST PRETENSIONED BOX BEAM BRIDGE
 ABUTMENT BACKWALL
 BUENA VISTA COUNTY
 APRIL 2009
 IOWA DEPARTMENT OF TRANSPORTATION - HIGHWAY DIVISION
 DESIGN SHEET NO. 5 OF 12 FILE NO. 30385 DESIGN NO. 109

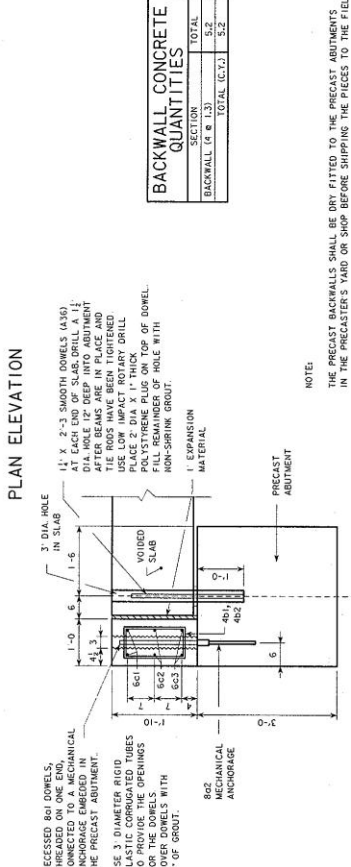
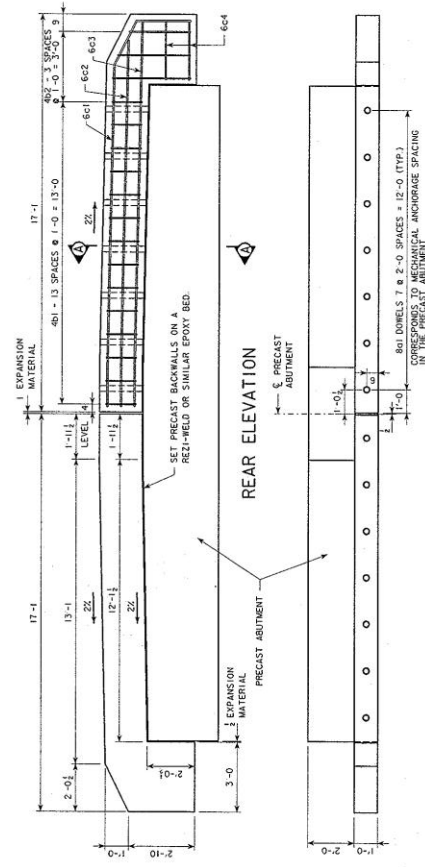

RECESSED 601 DOVELS, CONNECTED TO A MECHANICAL ANCHORAGE ASSEMBLY AT THE PRECAST ABUTMENT.

USE 3" DIAMETER RIGID TUBES TO PROVIDE THE OPENINGS FOR THE DOVELS. COVER DOVELS WITH 2" OF GROUT.

1" X 2'-3 SMOOTH DOVELS (3/16) DIA. HOLE 12" DEEP INTO ABUTMENT AFTER GROUTING AND THE BARS HAVE BEEN TIGHTENED.

USE LOW IMPACT ROTARY GRILL.

PLACE 2" DIA X 1" THICK POLYURETHANE GROUT TO FILL REMAINDER OF HOLE WITH NON-SHRINKING GROUT.

EXPANSION MATERIAL.

NOTE:
 THE PRECAST BACKWALLS SHALL BE DRY FITTED TO THE PRECAST ABUTMENTS IN THE PRECASTER'S YARD OR SHOP BEFORE SHIPPING THE PIECES TO THE FIELD. THE ENGINEER SHALL HAVE 48 HOURS NOTICE TO VIEW AND APPROVE THE CONNECTED PRECAST PIECES BEFORE THEY ARE SHIPPED TO THE FIELD.

BACKWALL CONCRETE QUANTITIES	
SECTION	TOTAL
BACKWALL 14' X 8'	5.2
TOTAL (G.C.)	5.2

SECTION A-A
 (SHOWING SLAB)

REINFORCING BAR LIST - ONE BEAM

BAR	SHAPE	NO.	LENGTH	WEIGHT
401	8	50'-8"	270	
402	4	5'-7"	15	
403	4	5'-7"	15	
404	6	4'-7"	18	
405	8	9'-5"	45	
501	2	9'-0"	15	
TOTAL WT. (LBS.)				832

NOTE: THE 401 BARS CAN BE DIVIDED INTO TWO PIECES WITH A 1" - 8 SPLICE FOR EASE OF CONSTRUCTION.

BENT BAR DETAILS

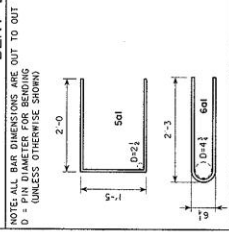

NOTE: ALL BAR DIMENSIONS ARE OUT TO OUT UNLESS OTHERWISE SHOWN.

AREA = 695 in²
 $f_y = 10.3 \text{ in}^2$
 $f_c = 1.287 \text{ in}^3$
 $S_x = 1.287 \text{ in}^3$

BEAM SECTION PROPERTIES

PLACE 1" THICK BY 4" PREFORMED EXPANSION JOINTS BETWEEN BEARING PADS

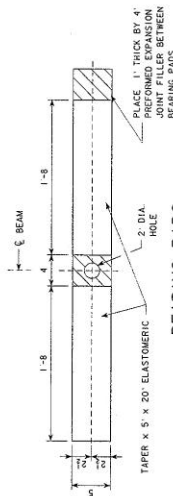

BEARING PADS (28 REQUIRED)

BEARING PAD - TAPER

BEAM NOTES:

THESE BEAMS ARE DESIGNED FOR HL-93 LOADING, PLUS 50 LBS PER SQUARE FOOT SURFACE LOAD. ALL PRESTRESSING STRANDS SHALL CONFORM TO ASTM A416 GRADE 270 LOW ALLOY STEEL. THE TOTAL INITIAL PRESTRESS FOR THE BOX BEAMS IS BASED ON 70,642 F OF INITIAL PRESTRESS. AS = 0.153 SQ. IN. THE MINIMUM STRAND CURVING STRENGTH SHALL BE 41.3 KIPS.

THE RELEASE AND FINAL CONCRETE STRENGTH SHALL BE A MINIMUM OF $f_{ci} = 6 \text{ ksi}$ AT RELEASE AND $f_{cs} = 7 \text{ ksi}$ AT 28 DAYS.

WHEN A TIGHT, UNIFORM SURFACE HAS BEEN ACHIEVED, THE BEAM SURFACES SHALL BE CLEANED AND CURING SHALL BE MAINTAINED THROUGHOUT THE CURE PERIOD. BROOM OR A COMB, THE BROOM OR COMB SHALL HAVE A SINGLE ROW OF TINES 1/2" IN WIDTH. THE DEPTH OF THE GROOVE IN THE PLASTIC CONCRETE SHALL BE TO THE CENTERLINE OF THE ROADWAY. TRANSVERSE GROOVING SHALL BE RANDOMLY SPACED FROM 1/2" TO 1" INCHES WITH NO MORE THAN 50% OF THE SPACINGS IN A 2' WIDTH. THIS OPERATION SHALL BE DONE AT A TIME AND MANNER THAT THE DESIRED TEXTURE WILL BE ACHIEVED WHILE MINIMIZING THE DISPLACEMENT OF THE LARGER AGGREGATE PARTICLES.

UNLESS OTHERWISE NOTED ALL BEAMS ARE TO BE INCREASED IN LENGTH BY 0.005L TO COMPENSATE FOR ELASTIC SHORTENING, CREEP AND SHRINKAGE. FOR TRANSPORTING, THE OVERHANG SHALL BE IN ACCORDANCE WITH ART. 2407.13 OF THE STANDARD SPECIFICATIONS.

BEARINGS SHALL BE AS DETAILED ON THIS SHEET. TO DETERMINE NEOPRENE BEARING STRENGTH, THE BEARING PADS AND THE NEOPRENE PADS SHALL BE INCLUDED IN THE PRICE OF THE BOX BEAM.

LIFTING LOOPS SHALL BE IDENTIFIED BY THE PRECAST MANUFACTURER AND SHALL BE ADJUSTED TO THE DESIGN TO THE CENTERLINE OF THE BEAM. ONCE IN PLACE THE LIFTING LOOPS SHALL BE CUT OFF 2" INCHES BELOW THE TOP SURFACE OF THE BEAM. THE CUTTING SHALL BE APPROVED BY THE ENGINEER WITH A GROUT MATERIAL APPROVED BY THE ENGINEER.

THE 1" Ø RODS IN THE TRANSVERSE TIE ASSEMBLY SHALL BE TIGHTENED TO A SNUG FIT AND THE THREADS SET. THE POCKETS THAT RECEIVE THE TRANSVERSE TIE SHALL BE FILLED WITH GROUT AFTER THE TRANSVERSE TIE ASSEMBLY IS IN PLACE.

THE 1" Ø THREADED GALVANIZED RODS SHALL BE IN ACCORDANCE WITH ASTM A 307-54 GRADE A. THE STRUCTURAL STEEL FOR THE PLATE WASHERS SHALL BE IN ACCORDANCE WITH ASTM A 709, GRADE 50. THE HEX NUTS FOR THE 1" Ø THREADED RODS SHALL BE IN ACCORDANCE WITH ASTM A 307-54 GRADE A. THE BOLTS SHALL BE IN ACCORDANCE WITH STANDARD SPECIFICATION 1128 2000 UNDER ANSI/AASHTO 11B.22.

IF NECESSARY, BEARING SEAT SURFACES SHALL BE ADJUSTED BY SHIMMING TO ASSURE FIRM AND EVEN BEARING OF THE BOX BEAMS. TWO 1/2" NEOPRENE ADJUSTING SHIMS WITH THE DIMENSIONS SHOWN FOR THE BEARING PAD SHALL BE PROVIDED FOR EACH BEARING. THE ENDS OF THE BEAMS SHALL BE INCLUDED IN THE PRICE BID FOR THE BOX BEAMS.

BEAM KEYWAY SURFACES SHALL BE CLEANED TO REMOVE FORM OIL OR OTHER BONDING AGENTS. THE BEARING PADS SHALL BE CLEANED AND THE SURFACES SHALL BE DONE BY SANDBLASTING THE KEYWAY AREAS BETWEEN THE TOP OF THE BEAM AND THE BOTTOM OF THE KEY.

THE ENDS OF THE BEAMS SHALL BE COATED WITH AN EPOXY GROUT TO HELP PROTECT THE STRANDS FROM WATER IN THE FIELD.

DESIGN STRESSES:

DESIGN STRESSES FOR THE FOLLOWING MATERIALS ARE TO BE IN ACCORDANCE WITH AASHTO LRFD SPECIFICATIONS UNLESS OTHERWISE NOTED:

PRECAST CONCRETE IN ACCORDANCE WITH SECTION 6, GRADE 60.
 $f_{cs} = 6000 \text{ psi}$
 $f_{ci} = 270,000 \text{ psi}$

SPECIFICATIONS:

CONSTRUCTION STANDARD SPECIFICATIONS OF THE IOWA DEPARTMENT OF TRANSPORTATION, CURRENT SERIES WITH CURRENT APPLICABLE SPECIAL PROVISIONS AND SUPPLEMENT.

DESIGN: AALS HT O, SERIES OF 2007, WITH MINOR MODIFICATIONS.

DESIGN FOR 0° SKEW
50'-0" X 28' PRECAST PRETENSIONED BOX BEAM BRIDGE
 50'-0" SPAN
 BOX BEAM DETAILS
 BUENA VISTA COUNTY
 IOWA DEPARTMENT OF TRANSPORTATION - HIGHWAY DIVISION
 DESIGN SHEET NO. 7 OF 12, FILE NO. 30355, DESIGN NO. 109

21" PRECAST PRESTRESSED VOIDED BOX BEAMS										
21" SLAB	SPAN LENGTH	OVERALL BEAM LENGTH (L)	CONCRETE STRENGTH (KSI)	STRAINING STRAIGHTENING	NO. OF STRAINING PIPS	TOTAL INFLUENCE	CAMBER (in)	WEIGHT (TONS)	CONCRETE (CU YD)	FINISHING (WEIGHT-LS)
21" SLAB	50'-0"	50'-0"	7.0	0.5	0	360.5	1.2	1.0	19	9.1
										852

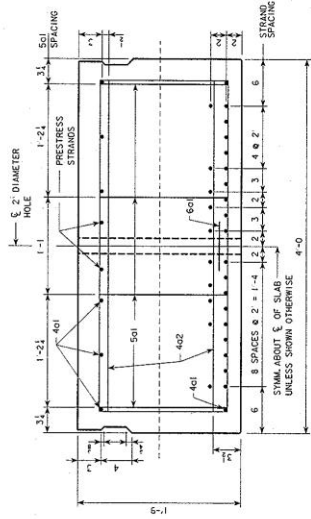

SECTION AT C BEARING

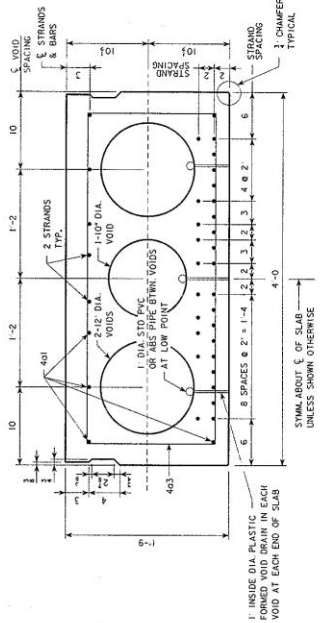

SECTION AT MIDSPAN

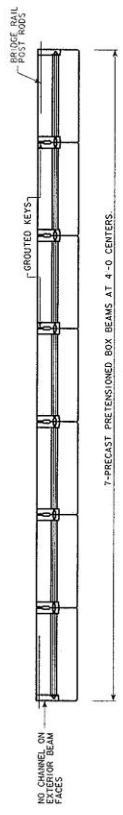

BOX BEAM ASSEMBLY

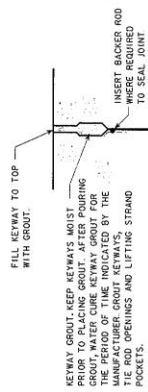

KEYWAY GROUT

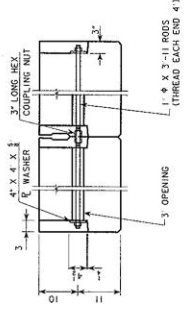

TRANSVERSE TIE ASSEMBLY

DESIGN FOR 0° SKEW
50'-0 X 28' PRECAST PRETENSIONED BOX BEAM BRIDGE
 BOX BEAM DETAILS
 STA. 11+35.4
 BUENA VISTA COUNTY
 IOWA DEPARTMENT OF TRANSPORTATION - HIGHWAY DIVISION
 DESIGN SHEET NO. B. OF 12. FILE NO. 20255. DESP#N KR. 102.
 BUENA VISTA COUNTY PROJECT NUMBER: IBRC-CO11861-SE-11
 APRIL 2009
 SHEET NUMBER 9

DESIGN TEAM
 07/JAN/2009 10:48
 W:\Projects\Bridges\Structure\Location\Buena Vista\BVF\Main\IBRCB8.Bridge.rvt © 2010/06/08 \v\pntwz2\l\gktdoc8.rvt
 BUENA VISTA COUNTY PROJECT NUMBER: IBRC-CO11861-SE-11 SHEET NUMBER 9

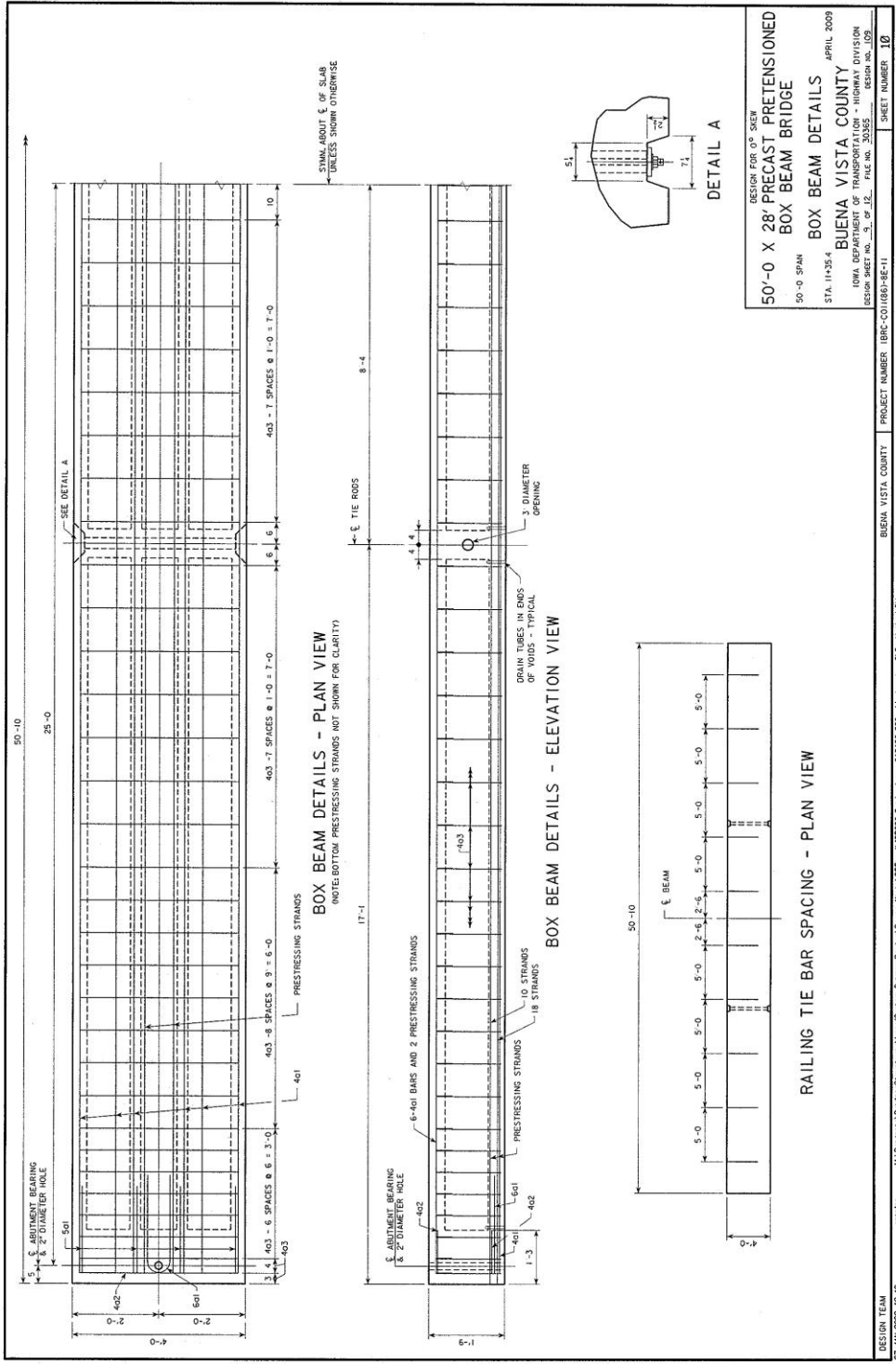

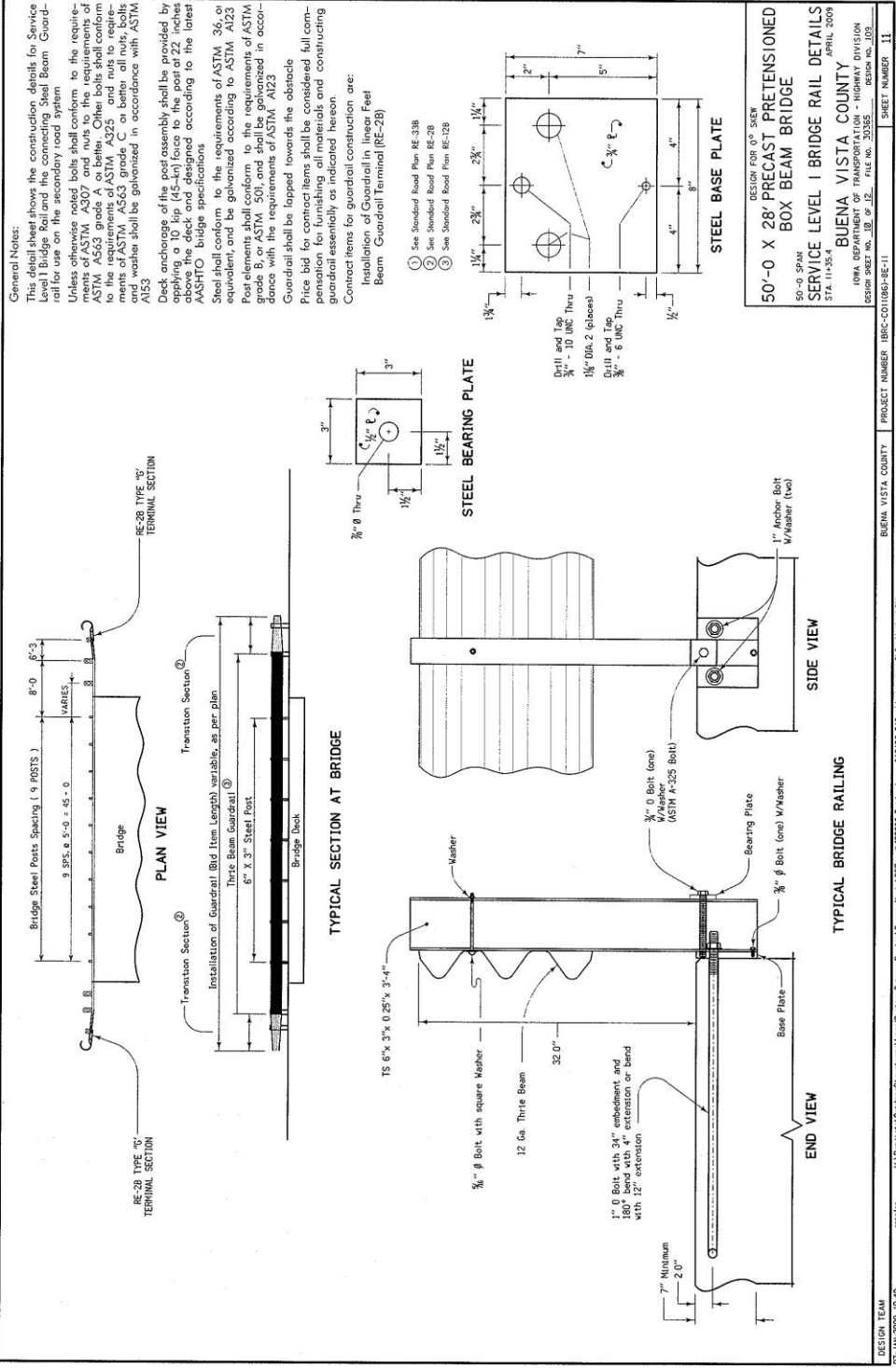

General Notes:
 This detail sheet shows the construction details for Service Level I Bridge and the connecting Steel Beam Guardrail for the bridge span.
 Unless otherwise noted, bolts shall conform to the requirements of ASTM A307 and nuts to the requirements of ASTM A563 grade A or C. Other bolts shall conform to the requirements of ASTM A325 and nuts to the requirements of ASTM A563 grade C or better. All nuts, bolts and washers shall be galvanized in accordance with ASTM A153.
 Deck anchors of this post assembly shall be provided by applicable local or state specifications. The anchor shall be above the deck and designed according to the latest AASHTO bridge specifications.
 Steel shall conform to the requirements of ASTM 36, or equivalent, and be galvanized according to ASTM A123.
 Post elements shall conform to the requirements of ASTM grade B, or ASTM 501, and shall be galvanized in accordance with the requirements of ASTM A123.
 Guardrail shall be lapped towards the obstacle.
 Price bid for contract items shall be considered full compensation for furnishing all materials and constructing guardrail essentially as indicated hereon.
 Contract items for guardrail construction are:
 Installation of Guardrail in linear Feet
 Beam Guardrail Terminal (RE-28)

① See Standard Road Plan RE-338
 ② See Standard Road Plan RE-28
 ③ See Standard Road Plan RE-128

DESIGN FOR 0" SKEW
50'-0" X 28'-0" PRECAST PRETENSIONED
BOX BEAM BRIDGE
SERVICE LEVEL I BRIDGE RAIL DETAILS
 APRIL 2009
 BUENA VISTA COUNTY
 IOWA DEPARTMENT OF TRANSPORTATION - HIGHWAY DIVISION
 DESIGN SHEET NO. 103
 FILE NO. 30355

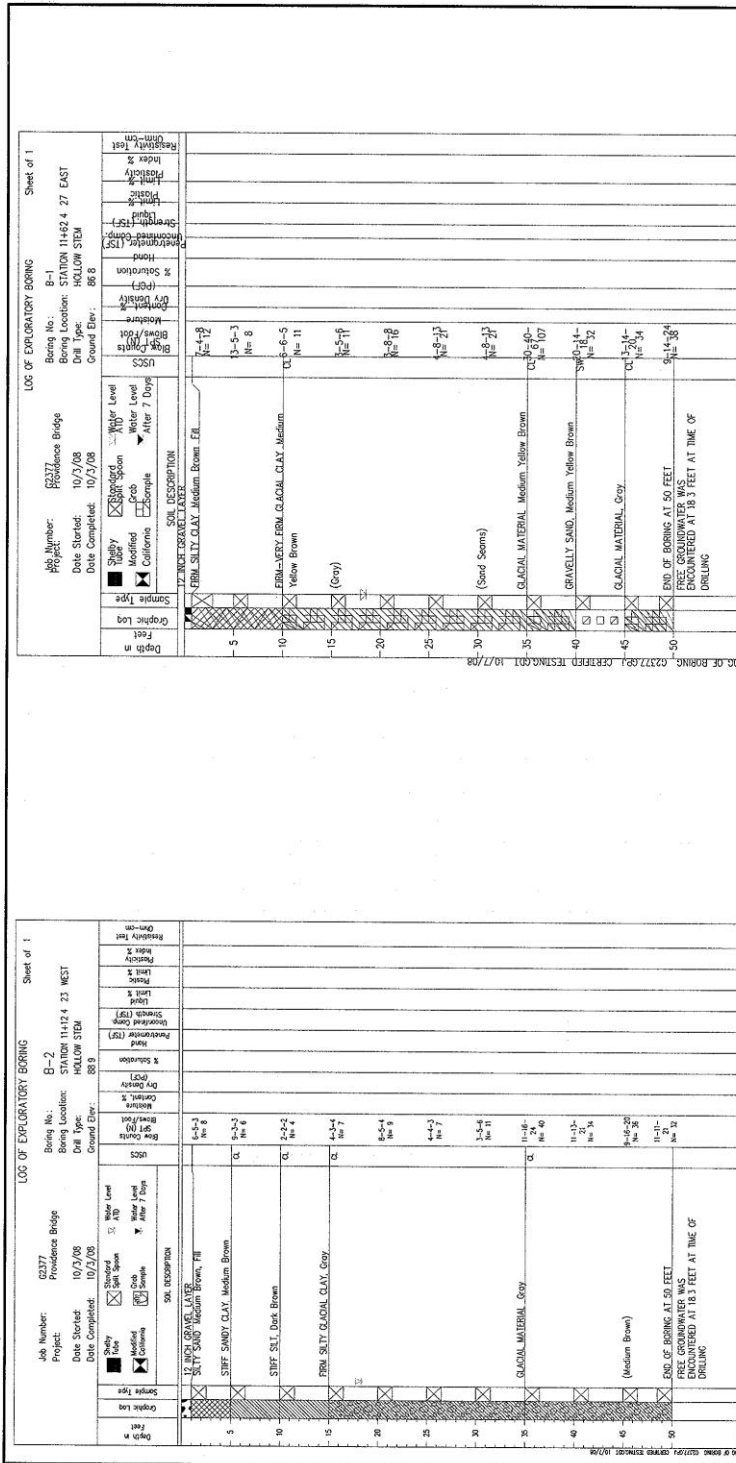

ROAD DESIGN

I hereby certify that this engineering document was prepared by me or under my direct supervision and that I am a duly licensed Professional Engineer under the laws of the State of Iowa.

Signature: John L. Iltis Date: _____
 Printed or Typed Name: _____
 My license renewal date is December 31, _____
 SHEETS 12 & 13 OF 13

Paper or sheets covered by this seal: _____

**DESIGN FOR 6" SKW
 50'-0" X 28' PRECAST PRETENSIONED
 BOX BEAM BRIDGE**

SOILS INFORMATION

BUENA VISTA COUNTY
 IOWA DEPARTMENT OF TRANSPORTATION - HIGHWAY DIVISION
 DESIGN SHEET NO. JL OF 12 FILE NO. 20585 DESIGN NO. 109

**BORING TAKEN AT WEST ABUTMENT
 OF THE EXISTING BRIDGE**

**BORING TAKEN AT EAST ABUTMENT
 OF THE EXISTING BRIDGE**

DESIGN TEAM
07/JAN/2009 10:49

W:\Projects\Bridges\Structures\LocalSystem_Primary\Borings\Buena Vista\BIR\Final\BIR038_Bridge.dwg 6/10/09 6:01 AM

PROJECT NUMBER: IIRC-C011060-0E-11

SHEET NUMBER: 12

FOR INFORMATION ONLY
ROAD GRADING WILL BE
PERFORMED BY THE COUNTY

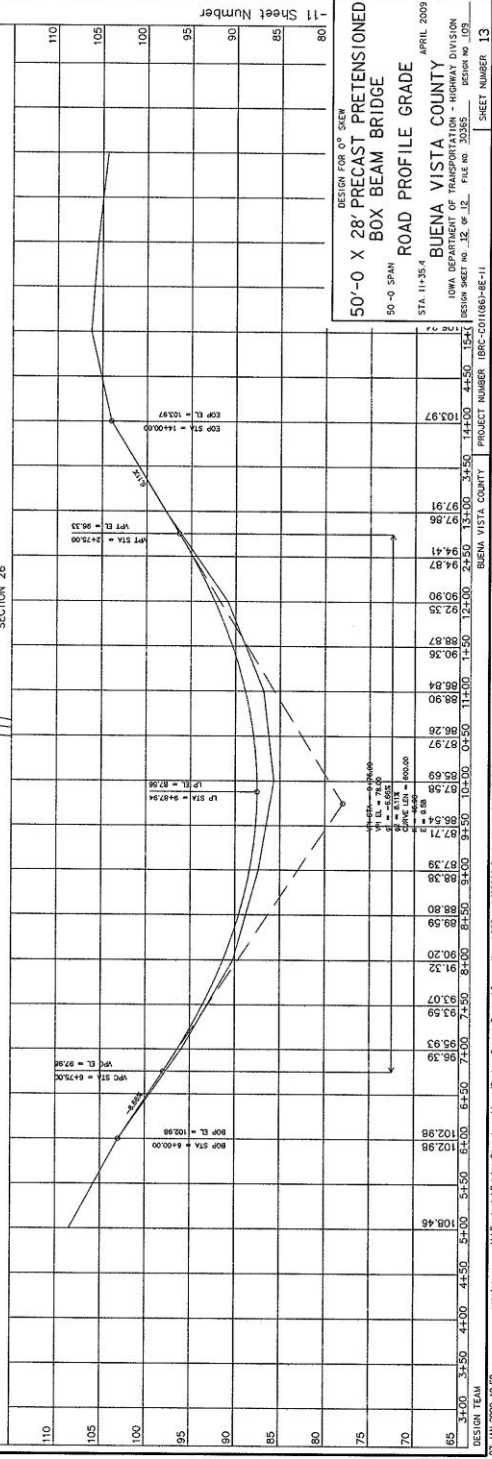
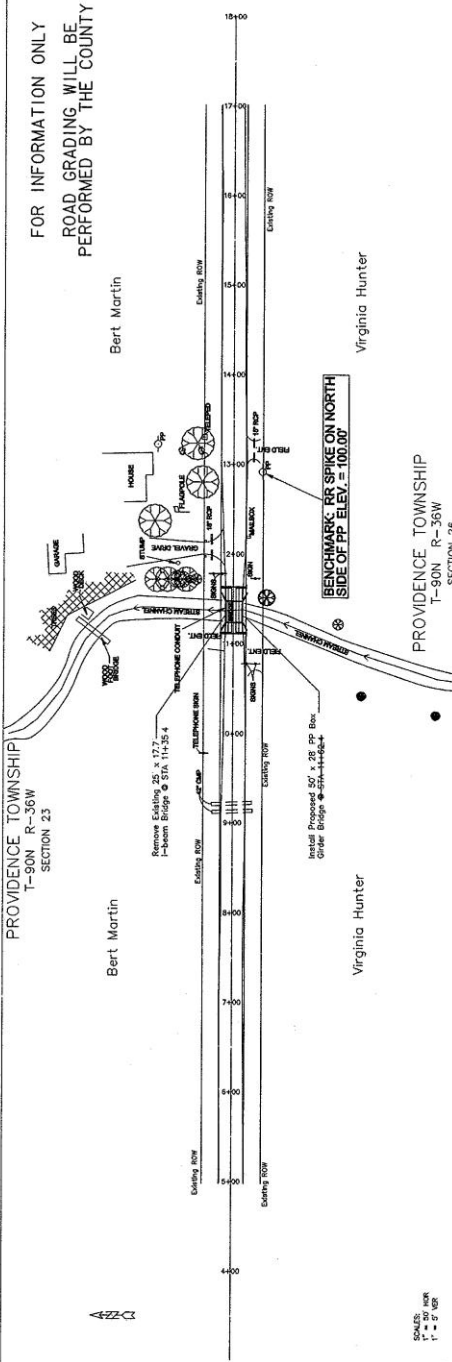

DESIGN TEAM	34+00	34+50	44+00	44+50	54+00	54+50	64+00	64+50	74+00	74+50	84+00	84+50	94+00	94+50	104+00	104+50	114+00	114+50	124+00	124+50	134+00	134+50	144+00	144+50	154+00
ELEVATION	95.39	95.39	95.39	95.39	95.39	95.39	95.39	95.39	95.39	95.39	95.39	95.39	95.39	95.39	95.39	95.39	95.39	95.39	95.39	95.39	95.39	95.39	95.39	95.39	95.39
PROPOSED ELEVATION	95.39	95.39	95.39	95.39	95.39	95.39	95.39	95.39	95.39	95.39	95.39	95.39	95.39	95.39	95.39	95.39	95.39	95.39	95.39	95.39	95.39	95.39	95.39	95.39	95.39

DESIGN FOR 0° SKEW
50'-0" SPAN
BOX BEAM BRIDGE
ROAD PROFILE GRADE
APRIL 2009
BUENA VISTA COUNTY
IOWA DEPARTMENT OF TRANSPORTATION - HIGHWAY DIVISION
DESIGN SHEET NO. 12, OF 12, FILE NO. 20285
PROJECT NUMBER (BRC-CO1186)-HE-11
SHEET NUMBER 13

