

All-Precast Substructure Accelerates Construction of Prestressed Concrete Bridge in New Hampshire



Peter E. Stamnas, P.E.

Senior Project Engineer
New Hampshire Department of
Transportation
Concord, New Hampshire



Mark D. Whittemore, P.E.

Design Chief
New Hampshire Department of
Transportation
Concord, New Hampshire

Minimizing construction-related traffic delays and improving work zone safety on future projects have been two reasons for the New Hampshire Department of Transportation's (NHDOT) foray into rapid construction of bridges. The NHDOT has pursued project innovations that could significantly affect methods of design, detailing, and construction of bridges in the future. This bridge project replaced two existing spans with a 115 ft (35.1 m) single-span precast, prestressed concrete box beam superstructure and precast concrete substructure. The contract required the bridge to be assembled and ready for traffic in two weeks. The contractor accomplished the task in only eight days. This article focuses on the substructure details and how the project schedule, design, specifications, and contractual arrangements for a conventional bridge-replacement project are affected by specifying rapid bridge construction. The general consensus is that all parties involved in this project are pleased with the outcome of this job.

The New Hampshire Department of Transportation (NHDOT) has taken a lead role in promoting the benefits of the use of high performance concrete (HPC) in bridges. This initiative has improved the quality of concrete used in bridge construction and extended the life of cast-in-place concrete decks and other precast/prestressed concrete bridge members.

A fast-track approach that integrates the use of HPC and precast/prestressed

concrete components was used on an NHDOT bridge-replacement project as a means to mitigate traffic delays and improve worker safety in construction zones. The existing crossing was replaced by a total precast concrete structure. The time allowed in the contract to assemble the new bridge and open it to traffic was limited to two weeks. The contractor exceeded all expectations by assembling the bridge in only eight days.



Fig. 1. View of Mill Street Bridge.

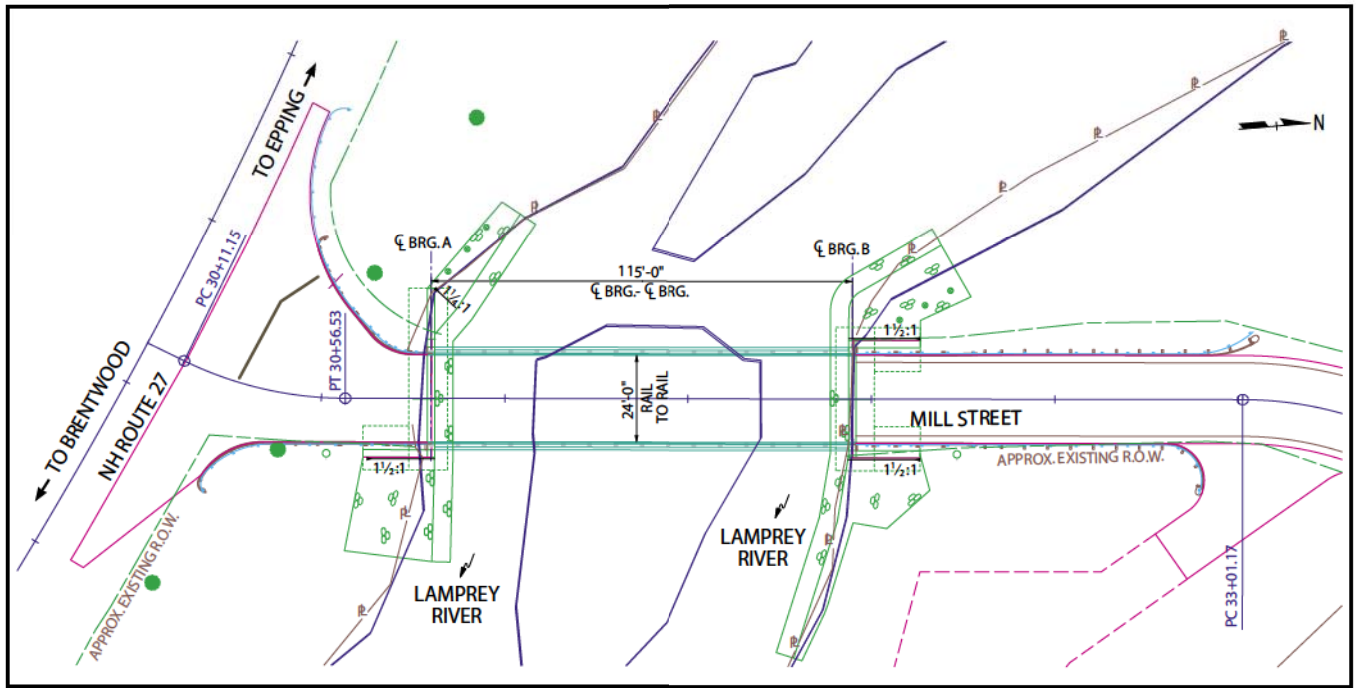

Fig. 2. General plan of the bridge site.

THE CHALLENGE

The Mill Street crossing in Epping, New Hampshire, was chosen as the first site to incorporate fast-track construction methods (see Fig. 1). One of the reasons this site was chosen was that its location minimized the overall risk of using a newly developed and untested substructure system. The NHDOT wanted to ensure the new system worked before it was incorporated into a high traffic volume, high-risk site

where it would be mandated to work.

The design issues at this site were challenging but fairly typical of New Hampshire's bridge projects. The former 120 ft (36.6 m) long crossing was composed of two 30 ft (9.14 m) long simple spans separated by a 60 ft (18.3 m) long center pier/causway. The south abutment was founded on shallow sloping bedrock, and the north abutment was founded on a granular material.

THE SOLUTION

The new structure used a 115 ft long, 3 ft deep (35.1 × 0.91 m) adjacent precast, prestressed box beam superstructure to span the river (see Figs. 2 and 3). The span range was extended with the use of 8000 psi (55 MPa) HPC and 0.6 in. (15.2 mm) diameter strand. Full-depth shear keys and two rows of ½ in. (12.7 mm) diameter strand were used to transversely post-tension the deck at six locations along the box beams.

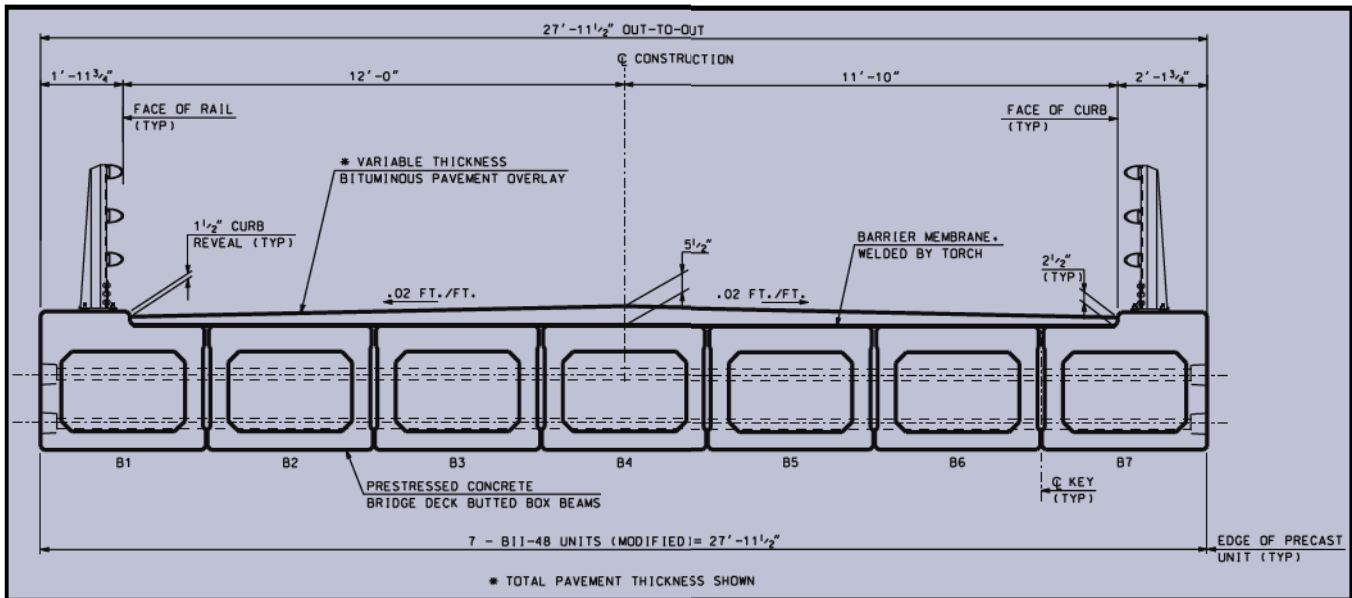

Fig. 3. Typical deck cross section.

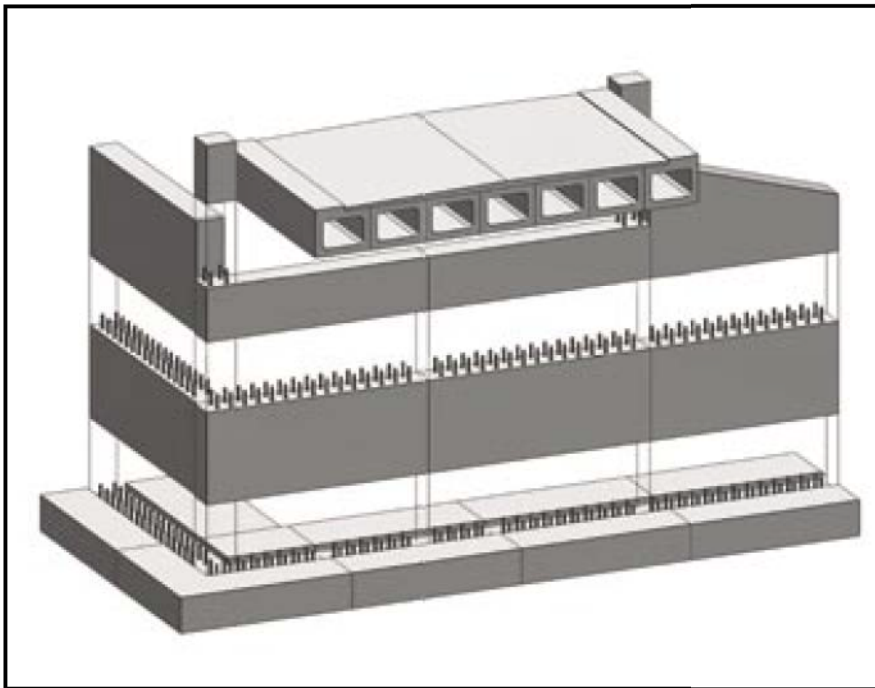

Fig. 4. Total precast solution.

The riding surface is composed of a waterproofing membrane and a bituminous pavement overlay. The superstructure is supported by an all-precast concrete substructure, composed of full-height cantilevered precast concrete abutments founded on precast concrete spread footings.

Precast Substructure System

Through the years, cast-in-place (CIP) concrete substructures have proven they can be adapted to varying

site conditions with ease; construction tolerance is inherent and overall familiarity with CIP concrete is universal in both design and construction. However, CIP substructures are time consuming to construct.

The NHDOT wanted to develop a new substructure system that would emulate the desirable aspects associated with CIP construction and improve on their less desirable aspects. Precast concrete substructures were the answer.

The main focus in the development of the new system was speed of construction, one that could be erected in a few days instead of a few months and to create a complete bridge system capable of spanning more than 115 ft (35.1 m) (see Fig. 4).

Early on, the team identified a number of specific issues and detailing requirements that would have to be addressed to meet this objective. Among these were:

- Create a total precast solution.
- Provide detailing to minimize shipping and handling difficulties.
- Accommodate tolerances in fabrication and construction.
- Provide effective, durable, and cost-effective connection details.
- Furnish a means for efficient grade adjustments of the footings.
- Provide a sound unified bearing surface with adequate sliding resistance.

The following details were developed and used on the contract drawings:

Full-height cantilevered abutments on spread footings (see Figs. 5 and 6)—This substructure type is used on a significant percentage of NHDOT bridge replacement projects. The CIP version would require six separate concrete placements and approximately one month to construct. The precast alternative can be completed in less than two days.

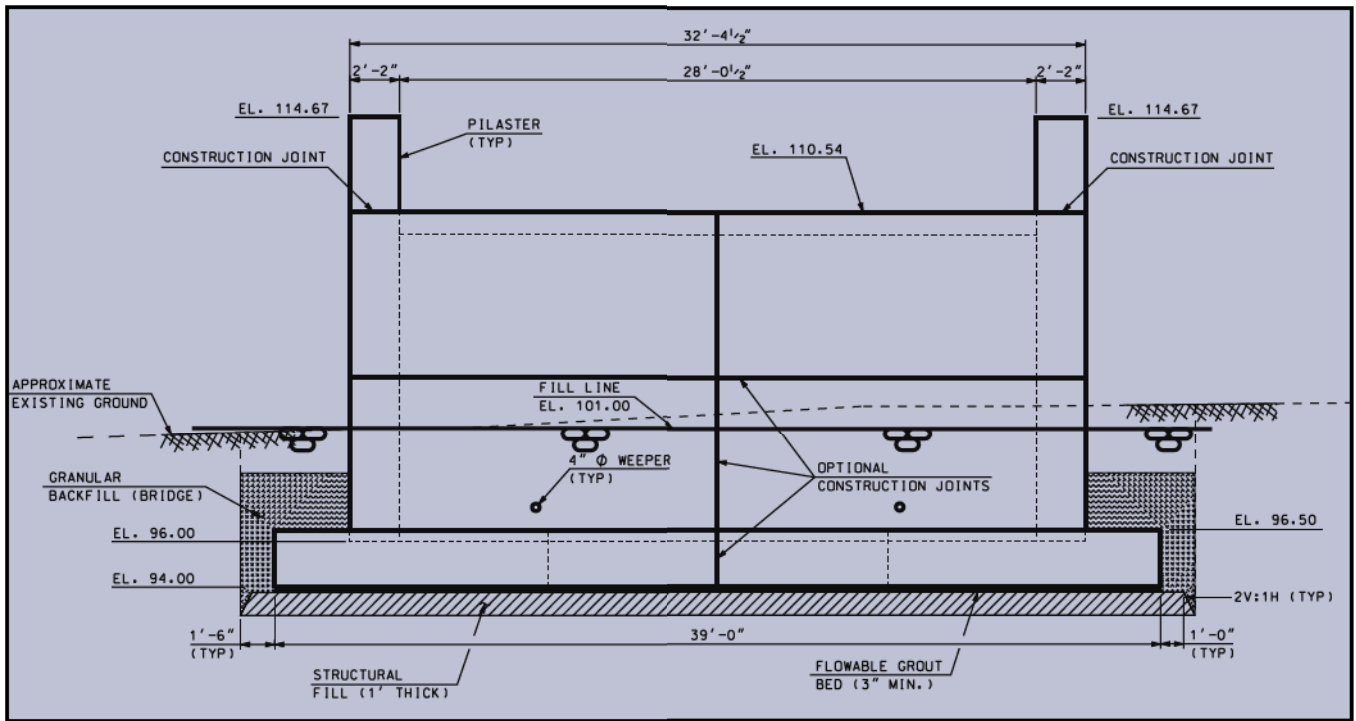

Fig. 5. Abutment elevation.

Flowable grout bed (see Fig. 6)—The 3 in. (76 mm) minimum thickness grout bed provides a sound, unified bearing surface that also acts as the “glue” between the bearing materials and the roughened bottom surface of the precast footing. The grout was placed through grout tubes in the footing that are spaced at 5 ft (1.52 m) intervals. The minimum compressive strength required to resist full design loading [approximately 250 psi (1.72 MPa) for this project] can easily be achieved overnight.

Precast footings—The footing was divided into individual elements to facilitate shipping and handling. The precaster can standardize element sizes to reduce fabrication costs. Templates used during fabrication ensure a proper fit between the stem and footing elements.

Leveling screws (see Fig. 7)—A simple cost-effective detail provided the means to make fine adjustments in setting the footings to proper grade. The leveling screws were installed near the corners of all footing elements.

Grouted shear keys (see Figs. 8 and 9)—All vertical joints between precast elements used grouted shear keys. These keys provide a means to accommodate fabrication and construction tolerances.

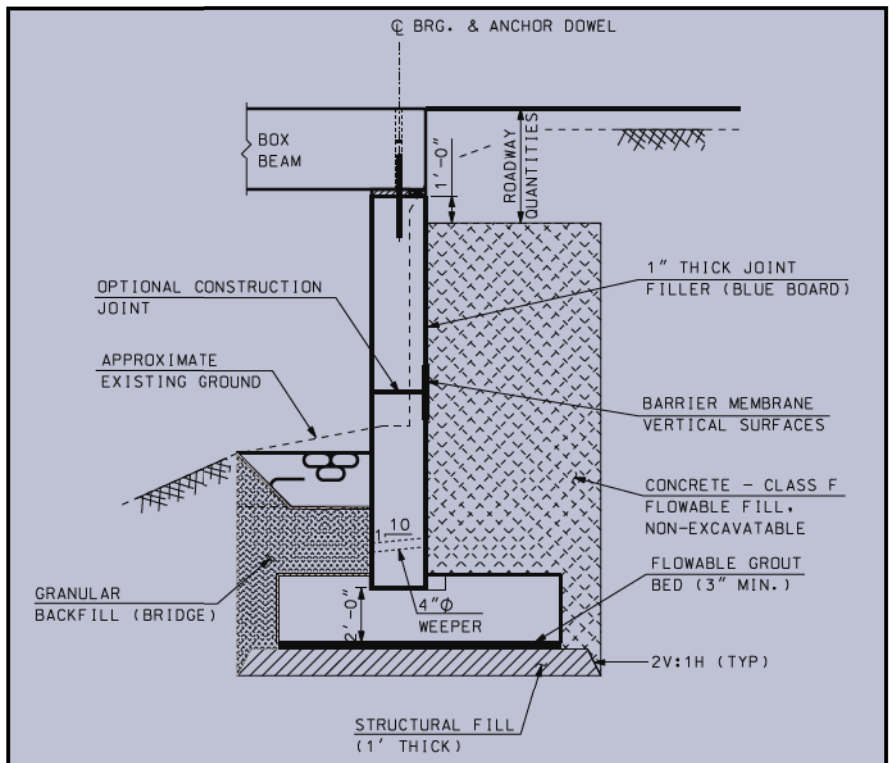

Fig. 6. Abutment section.

Table 1. Precast/prestressed concrete components.

10 Footing components	1380 sq ft
11 Abutment/wingwall components	1698 sq ft
4 Pilasters	36 sq ft
7 Prestressed box beams	3271 sq ft
32 total components	Total: 6385 sq ft

Note: 1 sq ft = 0.093 m².

Schedule and Costs Associated With Accelerated Construction

The original project concept included two separate challenges. These were (1) to limit the road closure to 30 days, and (2) to assemble the bridge in less than 14 days.

The first challenge required an approximate 80 percent reduction in the five-month time frame it would normally take to construct a project of this scope. This project-based goal incorporated all site-specific conditions into the equation.

The second challenge was introduced as the ultimate test for the new bridge system. The 14-day assembly window began with lifting operations to set the first precast element. This second challenge allowed the NHDOT to evaluate the effectiveness of the bridge system by removing all of the site-specific conditions from the equation.

Two separate incentive/disincentive clauses were included in this proposal: \$1,500 per day less/more than 30 days that the road had to remain closed, and \$2,500 per day less/more than 14 days that it took to assemble the bridge.

The project was originally advertised for bids in 2003. The low bid was well above the \$1 million budgeted for the project, and the bid was subsequently rejected.

The NHDOT made several modifications to the contract in an effort to reduce costs, most significantly by eliminating the 30-day road closure window. The incentive/disincentive money was also increased to \$5,000 per day. The modified project was re-advertised for construction in December 2003 and received a low bid of \$1,047,000.

In the end, the precast bridge component cost was \$445,000 and the total bridge cost was \$806,000.

Accelerated construction introduces risks to the contractor that affect the price of a bridge-replacement project. The cost increase might seem unjustified if the cost factors are limited to a comparison between bridge items only. A valid comparison must also include costs associated with traffic control and traffic delays. Some consideration must also be given to reduced environmental impacts, right-of-way issues, and the improved quality associated with the precast concrete elements.

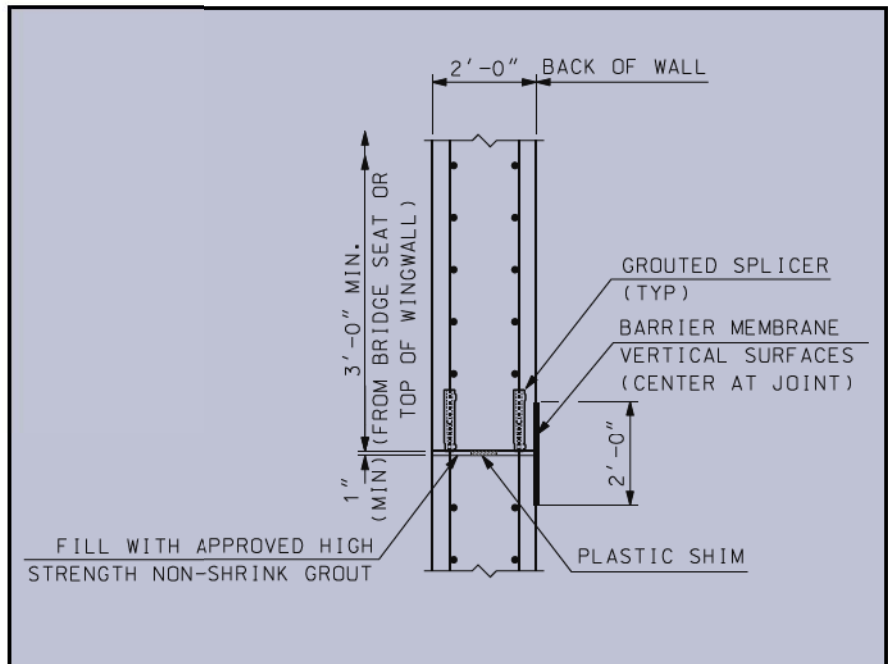

Fig. 10. Stem joint detail.

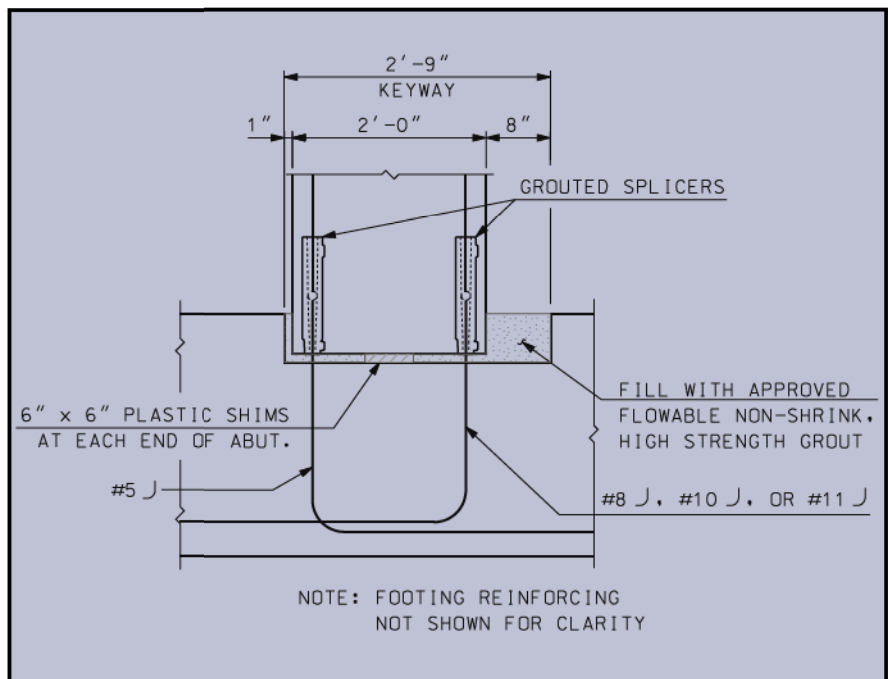

Fig. 11. Stem and footing joint detail.



Fig. 12. NMB grouted splicer.



Fig. 13. Abutment stem element, front side down.

Detouring traffic around a construction site is often a cost-effective way to address traffic control. However, the duration required to construct a bridge with conventional methods limits the feasibility of this alternative. This often leaves the designer with more expensive options, such as phased construction or a temporary bridge with on-site detours.

Costs for phased construction are not as easily quantified as a temporary bridge/detour, but it is estimated that they can increase typical bridge costs by 20 to 30 percent. Additional costs associated with traffic delays and safety are issues that are very difficult to quantify.

An accelerated timeline may eliminate the need for expensive on-site traffic control by making an off-site detour more palatable to the user. In

most cases, projects that use accelerated construction techniques will cost more to complete.

Tables 2, 3, and 4 list relevant substructure costs based on bid prices for the Epping project, as well as estimated costs for CIP construction.

Total Project Comparison

Some of the additional costs for this project can be attributed to the new concepts being applied. It is anticipated that prices will be reduced as the concepts become more commonplace and as contractors and precasters become more familiar with the details. The cost increase directly related to bridge items should be compared to the value the concept provides to the project as a whole, in order to determine whether the use of this concept is feasible for a specific project.

Project Timeline

Design of the bridge started in September 2002. The project was awarded to the contractor, R. M. Piper Construction, in January 2004, and six months later the fabrication of the precast/prestressed components began at the plant of J. P. Carrara & Sons, Inc., in Middlebury, Vermont. Upon completion, the precast pieces were transported by truck-trailer to the bridge site—a distance of about 170 miles (272 km). Precast erection began on August 19, and eight days later, precisely at 8:30 a.m., the bridge was opened to traffic.

Figs. 14 through 22 show various stages of the erection sequence. Fig. 23 is a closeup of the vertical shear key gap in the abutment stem. Figs. 24 and 25 show the grouting of the splice sleeve.

Figs. 26 to 28 show the completed Mill Street Bridge.

Table 2. Precast substructure cost.

Item	Quantity	Unit cost	Total cost
Precast substructure	2 units	\$100,000	\$200,000
Substructure assembly	2 units	\$ 22,500	\$ 45,000
Flowable grout bed	18 cu yd	\$400 per cu yd	\$ 7,200
Backfill	350 cu yd	\$100 per cu yd	\$ 35,000
Incentive	6 days	\$5,000 per day	\$ 30,000
Total			\$317,200

Note: 1 cu yd = 0.76 m³.

Table 3. Cast-in-place substructure cost estimate.

Item	Quantity	Unit cost	Total cost
Footing concrete	125 cu yd	\$225 /cu yd	\$ 28,125
Stem concrete	142 cu yd	\$425 /cu yd	\$ 60,350
Reinforcing bars	30,000 lbs	\$0.70 /lb	\$ 21,000
Backfill	350 cu yd	\$20 /cu yd	\$ 7,000
Subtotal			\$116,475
Temporary crossing			\$150,000
Total			\$266,475

Note: 1 cu yd = 0.76 m³; 1 lb = 0.45 kg.

Table 4. Total project cost comparison.

Item	Conventional construction	Rapid construction	Percent difference
Substructure cost (1)	\$116,000	\$317,000	175% increase
Temporary crossing (2)	\$150,000	\$0	
Subtotal = (1) + (2)	\$266,000	\$317,000	20% increase
Bridge item total	\$755,000	\$806,000	8% increase

LESSONS LEARNED

Using an all-precast concrete abutment system, the NHDOT was able to successfully mimic typical CIP concrete construction. However, the use of precast concrete substructures may require the engineer to settle for something less than the ideal solution to a geometric problem on a bridge replacement project. The engineer must focus on ease of fabrication, repetition, and ease of assembly to create a cost-effective precast solution.

The following concepts should be considered when detailing a precast concrete substructure:

1. There is a very high degree of precision required for the proper fit-up between precast components when using the splice sleeve connection. The inherent risk of error associated with this fit-up means that the precaster will almost always choose to use tall, narrow, vertical pieces, rather than shorter and wider pieces, thereby minimizing the number of splice sleeve connections required.

2. There is a significant advantage in being able to standardize the size of the precast components. Stem heights for abutments and wingwalls should be detailed in 6 in. (152 mm) increments, and site grading and appropriate choice of bottom of footing elevations should be used to fine-tune the solution.

3. Construction access is very important. Precast substructure elements weighing 30 tons (27 Mg) or more should be anticipated. The large cranes required will need an abundance of room.

4. Transportation of the precast components must be considered in design. Footings should have a maximum width of 12 ft (3.66 m) to avoid the need for overwidth permits. Thickness of stems should be minimized to reduce the overall weight.

5. Good detailing is a critical element in minimizing costs. Each component should be detailed such that each can be fabricated using simple flat-slab construction. Batters on abutment and wing stems should be avoided. Reinforcement layout should be simplified by using larger bars spaced further apart where possible. Footing widths should be detailed in 6 in. (152 mm) increments. Angles between abutment and wings should preferably be zero or 90 degrees.

There were a number of lessons learned from this project that will result in changes on future contracts:

1. Proper grouting of the key below the stem units is critical (see Fig. 11). The dimension of the key on the front face of the stem will be increased slightly from a 1 to 2 in. (25 to 51 mm) gap. In addition, the gap below the stem pieces will be increased from 1 to 1½ in. (25 to 38 mm). These changes will help ensure that grout completely fills the gap below the stems. Grouting of the stem-footing joint should be conducted from the front face side, and proper flowability of the grout should be closely monitored.

2. Grouting of the shear keys between vertical wall elements was problematic. Plywood forms anchored to the precast stem with field-drilled anchorages failed to adequately seal the joint under the significant head.

3. The minimum detailed shear key opening of 1 in. (25 mm) was inadequate (see Fig. 23). This was especially a problem with trapezoidal-shaped wing elements where it was very difficult for the units to be lifted plumb. The inadequate joint width was compounded by the use of a ½ in. (12.7 mm) thick cork joint between the wing and abutment. The cork had to be removed to



Fig. 14. Day 1, 5:05 a.m.: Footings complete.



Fig. 15. Day 2, 11:17 a.m.: Setting abutment panels.



Fig. 16. Day 4, 10:47 a.m.: Backfilling substructure.



Fig. 17. Day 5, 5:07 p.m.: First beam set.



Fig. 18. Day 5, 7:37 p.m.: Setting fourth box beam.



Fig. 19. Day 6, 5:57 p.m.: Setting last beam.

provide an adequate joint for assembly tolerance.

The following modifications of vertical joint details are proposed for future projects:

1. Eliminate the vertical shear key detail between wall elements [except on walls more than 20 ft (6.10 m) high].

2. Increase the dimension of the joint opening between vertical elements to 1½ in. (38 mm).

3. Fill all vertical joints less than 20 ft (6.10 m) in height with an expanding foam sealant.

4. Size each of the four leveling bolts/screws to carry 100 percent of the footing load. During leveling operations, the entire weight of the footing pieces was often on just two of the leveling bolts (see Fig. 7).

5. Pay special attention to proper grouting beneath the footings. During grouting operations, high volumes of grout need to be maintained to make sure grout gets to the edge of the footing.

6. Complete the splice sleeve grouting operation in a minimal amount of time (approximately 150 sleeves per hour). The grout used is a proprietary product and requires special equipment and procedures. A basic two-hour seminar on proper grouting techniques should be required for field personnel. A curing time of 12 to 16 hours should be anticipated to reach minimum grout strength prior to backfilling operations.

SUMMARY AND CONCLUSIONS

The use of accelerated construction techniques, in conjunction with high performance concrete, is an important tool for reducing construction related traffic delays, improving work zone safety, and extending the long-term durability of bridges. This concept is not viewed as the solution for all the ills of the infrastructure. Rather, it is another tool that bridge engineers can use when the conditions are appropriate.

The following items are offered as observations:

1. The precast concrete substructure system detailed for use has promise.

The system has a number of key advantages:

- Emulates the favorable aspects of CIP construction.
 - Uses standard design concepts.
 - Uses elements produced locally with readily available materials.
 - Is easy to construct and assemble.
 - Is durable when constructed properly.
- Improves on the less-favorable aspects of CIP construction.
 - Significantly reduces the time to construct the substructure.
 - Is constructed to tight tolerances.
 - Provides a high-quality solution using HPC.

2. Accelerated construction improves work zone safety.

Partial use of the techniques may be the right answer in many instances. Precast substructures could be used on bridge projects that cross commuter rail lines. The advantage of precast elements is that they can be readily assembled within the available construction window. Savings realized on items such as the reduced rental time for a temporary bridge and wasted labor to mobilize the construction crew around these windows would compensate for the additional costs associated with the fabrication and delivery of precast elements.

3. Precast elements can be used to address labor limitations.

Aggressive construction schedules have been increasingly commonplace and may require the contractor to mobilize two or more crews working in parallel to meet the completion schedule. Consequently, many smaller contractors may not be able to bid on a project of this nature. Accelerated construction techniques using precast elements might offer more bidding opportunities for small contractors, thus increasing competition, which could ultimately reduce construction costs.



Fig. 20. Day 7, 10:27 a.m.: Preparing for transverse post-tensioning.



Fig. 21. Day 8, 9:40 a.m.: Completing riprap.



Fig. 22. Day 8, 5:40 p.m.: Deck membrane complete, awaiting pavement.

4. Accelerated construction minimizes construction related traffic delays on high volume roads.

On-line reconstruction of bridges on high volume roadways can extend the construction duration of a typical crossing into a second construction season. The impact of this extension on the user can be significant. Consideration of user cost savings could offset the increased costs associated with accelerated construction.

5. Accelerated construction increases initial cost.

Accelerated construction creates

risks for the contractor that will increase costs. The magnitude of the cost increase will vary from project to project and will be highly dependent on site-specific conditions. As the risks to the contractor are reduced, project costs are also reduced.

In analyzing the project, it is very clear that the increased cost of bridge items due to accelerated construction techniques should be compared to the value they bring to the project as a whole. The value comparison must include potential cost savings associated with traffic control items and the reduc-

tion in life cycle costs of the bridge due to the improved quality of the precast concrete solution.

6. Grouted joints between precast elements should not be a weak link.

Grouted joints typically draw a significant amount of attention from bridge engineers. It is very common for these joints to be viewed as a small piece of the overall construction effort by contractors. As such, sometimes limited attention is paid to preparing and grouting the joint properly. Deterioration of the joints can expose the structural components to the elements and reduce the lifespan of the entire system. Therefore, attention must be focused on these details during construction.

For example, shear keys must be sandblasted to remove any laitance that would inhibit bond. Also, grouts used to fill the joints must be mixed to the manufacturer's recommendations for them to be effective.

Grouted shear keys in this substructure system should be viewed as a critical detail even though the exposure conditions for substructures in most environments are typically lower than those experienced by superstructures. Exposure conditions, such as saltwater environments, should always be considered before deciding whether to use precast concrete substructure elements with grouted shear keys.

An important lesson learned from this project was that the contractor and precaster will do everything possible to minimize the total number of substructure elements required. It is more cost-effective to fabricate, ship, and install one element, rather than two or more, for the same footing or wall surface area.

7. The best delivery concept may be to substitute precast substructure components for CIP elements.

With this concept, the typical CIP elements would be designed and detailed for use on the contract drawings. Standard details for emulating the CIP elements would also be included. The NHDOT would set the completion date, and the contractor would decide what means and methods are required to complete the work on time. The contractor factors the cost into the bid price without limiting the potential solutions.

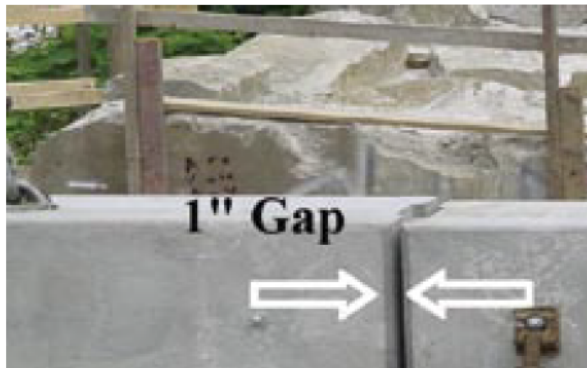



Fig. 23. Vertical shear key in abutment stem.



Fig. 24. Grouting splice sleeves.



Fig. 25. Closeup of grouting splice sleeve.



Since colonial times, the people of New Hampshire (the Granite State) have shown a spirit of independence, intellectual freedom, and innovation. For example, during Presidential elections, the New Hampshire Primary is the nation's first primary and often considered a trend setter. And so, it is with this pioneering spirit that the New Hampshire DOT spearheaded this demonstration project. Here's what several key decision-makers had to say about the Mill Street Bridge in Epping, New Hampshire:

"The Mill Street Bridge project was a well-planned and well-executed project. The bridge is located in the downtown section of Epping. While you would expect a large project such as removing and replacing a bridge in the center of town would be disruptive for months, this project took only a few weeks and had minimal disruptions to the surrounding area. I heard no complaints during the construction process, and have heard numerous compliments on its design and the aesthetics of the bridge."

—*Stephen R. Fournier*
Town Administrator, Town of Epping

"The greatly reduced construction time enabled us to easily schedule with the general contractor project tasks that were identified as a Town Highway Department responsibility. These tasks were identified by the NHDOT in cooperation with the town to reduce total project cost to meet a budget."

—*David Reinhold*
Director, Epping Highway Department

"With all the initial local TV exposure, public meetings, and personal contact with the town project representative, the abutters were very excited to see the project start. Many of us visited the site daily to watch the amazing hour-to-hour progress. Everyone—NHDOT engineers, R.M. Piper's crews, and academics—were very cordial to all the spectators. It was a great eight-day show of ingenuity."

—*Benny and Carol Morin*
Abutter

"The short time frame and non-changing traffic pattern for the work zone greatly simplified our department's response planning. We were able to identify and post for our 60-plus staff of full-time [employees] and volunteers a single detour route that would be available 24 hours a day during the full duration of the project."

—*Brian Toomire*
Fire Chief, Town of Epping

The downside of this delivery concept is that the owner cannot take proper advantage of the potential savings in engineering and plan preparation costs. The substructure detailing on the Epping Rapid Bridge Replacement Project was reduced by half, from ten plan sheets to five.

The NHDOT views its first rapid bridge replacement project in Epping as a great success and a starting point for a promising concept. The expected long-term benefits of the use of HPC in bridges are well documented, but they come at a price.

The NHDOT views the introduction of precast concrete elements to bridge substructures in the same light. The ease of construction and the overall effectiveness of the details used on this project have demonstrated the viability of this system and opened the door for many applications in the future. Such techniques are not limited to the



Fig. 26. View of the completed south abutment.



Fig. 27. Another view of the completed abutment and substructure.



Fig. 28. Finished view of Mill Street Bridge.

NHDOT but can be applied by other transportation agencies.

This project has provided a valuable learning experience to the NHDOT and all those involved in the design and construction effort of this bridge. The NHDOT looks forward to confronting the challenges created by using rapid bridge construction techniques on future projects.

The Mill Street Bridge project won two awards in the 2005 PCI Design Awards Program—one for “Best Bridge with Spans Between 65 and 135 ft (20 and 41 m)” and the other for “Best All-Precast Solution.”

The jury’s comments for the first award were as follows:

“The most impressive feature of this bridge is that by making the substructure totally precast, the construction schedule of this project was significantly accelerated. The use of multiple precast elements, in particular spread footings, for the substructure is commendable. As contractors and precast-

ers become more familiar with this construction method, they will be able to apply the technique to a broad range of bridges, especially in rural areas.”

The jury comments for the all-precast solution award were as follows:

“When it comes to building our nation’s roadways, the FHWA philosophy for many years has been to ‘get in, get out, and stay out.’ By using an all-precast solution for the substructure (comprising footings, abutments, wingwalls and pilasters), the entire bridge was built in only eight days. The design team devised a creative solution and, with the close cooperation of the contractor and precaster, they made it work very efficiently. The end result is an attractive bridge built ahead of schedule, which is bound to impact the future of bridge construction.”

ACKNOWLEDGMENTS

The authors would like to extend their appreciation to the Federal High-

way Administration, which provided funding for this project through the Innovative Bridge Research Program. In addition, the authors gratefully acknowledge the substantial assistance and input provided by the PCI Northeast Region Technical Committee and the University of New Hampshire in the development of the project details.

CREDITS

Owner: Town of Epping, New Hampshire

Engineer of Record: New Hampshire Department of Transportation, Concord, New Hampshire

Design/Construction/Inspection Team: Jason Tremblay/Steven Ireland, NHDOT, Bureau of Bridge Design and Construction

General Contractor: R. M. Piper Construction, Plymouth, New Hampshire

Precaster: J. P. Carrara & Sons, Inc., Middlebury, Vermont